



RECOIL®

Price
List
2013



Table of Contents

Introduction.....	3
Standard Kits Metric.....	4
Standard Kits Inch.....	6
Kits other.....	8
Replacement Insert Packets for Kits and Merchandiser - Metric.....	9
Replacement Insert Packets for Kits and Merchandiser - Inch.....	10
Range Kits.....	12
Re-Grip / Plugsaver / Gauges / Tapping Fluid / Drill-Out / X-Out.....	13
Tangless Inserts.....	14
Tangless Inserts - Screw Locking.....	15
Bulk Inserts Free Running - Metric.....	16
Bulk Inserts Free Running - Metric - Sparkplug and Lefthand Thread.....	23
Bulk Inserts Free Running - UNC/UNF.....	24
Bulk Inserts Free Running - BSW/BSF.....	28
Bulk Inserts Free Running - BA/BSC/BSP.....	30
Bulk Inserts Free Running - BSP/Special Threads/UN/UNC LHT.....	31
Bulk Inserts Free Running - UN/UNC LHT/Bicycle Threads.....	32
Bulk Inserts Screw Locking - Metric.....	33
Bulk Inserts Screw Locking - UNC/UNF.....	37
Bulk Inserts Screw Locking - 8 TPI UN.....	41
Inserts - Stripfeed - Metric.....	42
Inserts - Stripfeed - Inch.....	44
Taps - Straight Flute Taps (Hand/Short Machine).....	45
Taps - Straight Flute & Spiral Point Taps (Machine).....	47
Taps - Straight Flute Taps (Hand/Short Machine).....	48
Tap Coatings - TiN - Titanium Nitride Coating.....	51
Gauges - For Gauging STI Holes.....	52
Power Installation Tools.....	54
Standard Insertion Tools - Tool Fit Chart.....	56
Electric Installation Tools - Tool Fit Chart.....	59
Carbon Steel Bulk Keyserts - Metric.....	61
Stainless Steel Bulk Keyserts Thread Insert Bulk.....	63
Stainless Steel Bulk Keyserts Thread Insert Bulk.....	64
Carbon & Stainless Steel Keysert Thread Insert.....	65
The Recoil Tapper System - Metric.....	66
The Recoil Tapper System - Inch.....	68
Tapper Instalation tools.....	69
Thread Identification and Drill Chart.....	70
Terms and Conditions.....	71

Introduction

Alcoa Fastening Systems' (AFS) Recoil manufacturing operations are located in Australia, with sales and warehouse facilities strategically located in North America, Asia, and Europe. Extensive worldwide distribution, coupled with the company's manufacturing strategy, offers significant advantages to end users.

Alcoa Fastening Systems ensures a global consistency of quality design standards in manufacturing the full range of wire thread inserts in one production facility. Users around the world can be assured of high standards and the consistency of all AFS products. Inserts are manufactured in standard sizes for all metric and inch thread forms. A comprehensive design facility is available to ensure that non-standard inserts can be manufactured for special part requirements.

Prompt availability of products to customers worldwide is ensured by an efficient international freight service and a network of stocking distributors. Alcoa Fastening Systems is committed to the highest quality products and operating systems and employs a strict quality management system in accordance with:

- AS9100 accreditation
- ISO9001 accreditation
- TS16949 accreditation
- ADS
- TS157 approval
- ISO14001 Environmental Systems

Alcoa Fastening Systems will provide technical assistance to production engineers so that optimum installation efficiency can be achieved and maintained. Recoil brand coils are available to the following international and customer standards:

- NASM122076 Series - Free Running - UNC
- NASM21209 Series – Locking UNC and UNF
- BS7751 - Metric - Coarse
- BS7753
- MA3279, MA3280, MA3281 - Metric - Free Running
- AS6733 Series - UNF - Unplated
- AGS3600 Series - UNF - Cad. Plated - Self Locking
- General Electric - C981, N926 Series, N913
- DIN8140
- NASM124651 Series - Free Running - UNF
- NASM8846
- BS7752 - Metric - Fine
- BS4377
- MA3329, MA3330, MA3331 - Metric - Self Locking
- AS8455 Series - UNF - Cadmium Plated
- AGS3700 Series - Nimonic Alloy 90 - Self Locking
- LN9499, LN9039
- BACI12AE - Boeing

How to install Recoil inserts.



1. **DRILL:** Drill to clear out the damaged thread with drill size as specified on kit (if necessary).

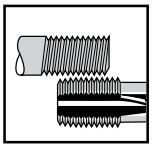

2. **CHECK:** Ensure tap thread matches bolt.



3. **TAP:** Place tap into tap wrench or use the square drive in the installation tool if provided. (Square drive tool only suitable for tapping non-ferrous alloys.)

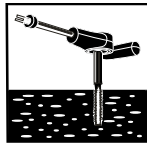

3a. **TAP HOLE:** Tap hole to the required depth using correct procedures (if unsure contact your dealer).

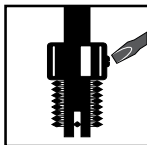

4. **SET TOOL:** Place insert on installation tool, positioning the adjustable top so that the insert tang is centered in the tang slot.

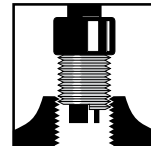

5. **INSTALL:** Wind insert in with light downward pressure until 1/4 to 1/2 turn below the surface.

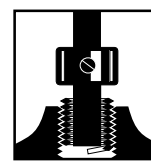

6. **TANG REMOVAL:** Do not attempt to twist tang off with tool. Lift tool from tang, turn tool 90° and tap down sharply. Use Tang Break Tool where supplied. For sparkplug and large fine thread inserts, use long nose pliers to pull tang out.

Thread Repair Kits Metric

Kit includes:

- High Speed Steel Drill
- HSS STI Tap
- Combination Tap and Installation Tool*
- Magnetic Tang Removal Tool
- Quantity of Inserts
- Easy to follow instructions
- All contained in a quality case



The Recoil Trade Series Kit includes only the best quality HSS taps which make them suitable for aluminium, magnesium, cast iron and most machinable steels. Everything you need for complete thread repair in one handy case.



Includes (sizes up to and including M12, 1/2")

- 1 New combo tap and installation tool
- 2 Magnetic Tang Break Tool (for easy tang removal in blind holes)
- 3 H.S.S. Drill

Size	Metric Coarse 35000+	*	Metric Medium 37000+	*	Metric Extra Fine 38000+	*	Inserts per Kit	Price per Kit
	Part No.		Part No.		Part No.			
M2 x 0.4	35028	*					15	109.51
M2.2 x 0.45	35018	*					15	77.30
M2.5 x 0.45	35258	*					15	105.65
M3 x 0.5	35038	*					15	69.58
M3.5 x 0.6	35358	*					15	69.58
M4 x 0.7	35048	*					15	55.65
M5 x 0.8	35058	*					15	46.38
M6 x 1	35068	*					15	46.38
M7 x 1	35078	*					15	57.97
M8 x 1			37088	*			15	63.78
M8 x 1.25	35088	*					15	55.65
M9 x 1			37098	*			15	77.30
M9 x 1.25	35098						15	69.58
M10 x 1					38108	*	15	85.04
M10 x 1.25			37108	*			10	75.37
M10 x 1.5	35108	*					10	70.72
M11 x 1					38118	*	10	96.63
M11 x 1.25			37118	*			10	96.63
M11 X 1.5	35118	*					10	86.98
M12 x 1					38120-1	*	10	184.05
M12 x 1.25					38128	*	10	98.16
M12 x 1.5			37128	*			10	90.44
M12 x 1.75	35128	*					10	88.12
M13 x 1.5			37138				6	127.56
M13 x 1.75	35138						6	115.96
M13 x 1.25					38138		6	140.44
M14 x 1.5			37148				6	119.81
M14 x 2	35148						6	115.96
M14 x 1.25					38148		6	87.79
M15 x 1.5			37158	*			6	141.11
M15 x 2	35158						6	141.72

* Drill and magnetic tangbreak tool included

Thread Repair Kits Metric

Size	Metric Coarse 35000+	Metric Medium 37000+	Metric Extra Fine 38000+	Inserts per Kit	Price per Kit	
	Part No.	Part No.	Part No.			Part No.
M16 x 1.5		37168		6	134.97	
M16 x 2	35168			6	120.59	
M18 x 1.5			38188	6	127.61	
M18 x 2		37188		6	219.02	
M18 x 2.5	35188			6	206.14	
M20 x 1.5			38208	6	251.23	
M20 x 2		37208		6	251.23	
M20 x 2.5	35208			6	244.79	
M22 x 1.5				38220	5	282.22
M22 x 2				37220	5	282.22
M22 x 2.5				35220	5	276.09
M24 x 1.5				38240	5	392.65
M24 x 2				37240	5	392.65
M24 x 3				35240	5	349.71
M26 x 1.5				38260	5	454.00
M27 x 1.5				38270	5	454.00
M27 x 2				37270	5	454.00
M27 x 3				35270	5	429.46
M30 x 1.5				38300	5	546.03
M30 x 2				37300	5	539.89
M30 x 3				35300-3	5	527.62
M30 X 3.5				35300	5	527.62
M33 x 2				37330	5	613.51
M33 x 3.5				35330	5	601.24
M36 x 1.5				38360	4	699.40
M36 x 3				37360	4	699.40
M36 X 4.0				35360	4	681.00
M39 x 2				38390	4	809.83
M39 x 3				37390	4	809.83
M39 x 4				35390	4	797.56
M42 x 2				38420	4	932.54
M42 x 3				37420	4	932.54
M42 x 4.5				35420	4	920.27
M42 x 4				35420-4	4	920.27
M45 x 4.5				35450	4	1046.67

Left Hand Threads Kits				Pilot Nose Taps Kits			
Size	Part No.	Inserts in kit	Price	Size	Part No.	Inserts in kit	Price
6 - 1	35068LH	10	246.00	6 - 1	35063	10	79.95
8 - 1.25	35088LH	10	246.00	8 - 1.25	35083	10	92.22
10 - 1.5	35108LH	10	246.00	10 - 1.5	35103	10	79.66
12 - 1.75	35128LH	5	246.00	10 - 1.25	37103	10	79.66
				12 - 1.75	35123	5	120.05

* Drill and magnetic tangbreak tool included

Australian Price List Effective May 2013

Note! All prices are exclusive of GST



Thread Repair Kits Inch

Size	UNC 33000+ Part No.		UNF 34000+ Part No.		UNC 33000+ Part No.		UNF 34000+ Part No.		Inserts per Kit	Price per Kit
#2 - 56	33528	*							15	70.859
#3 - 48	33538	*							15	70.859
#3 - 56			34538	*					15	70.859
#4 - 40	33548	*							15	63.780
#4 - 48			34548	*					15	70.859
#5 - 40	33558	*							15	63.780
#6 - 32	33568	*							15	60.298
#6 - 40			34568	*					15	105.522
#8 - 32	33588	*							15	60.298
#8 - 36			34588	*					15	105.511
#10 - 24	33608	*							15	54.502
#10 - 32			34608	*					15	54.502
#12 - 24	33628	*							15	60.559
#12 - 28			34628	*					15	60.548
1/4 - 20	33048	*							15	48.706
1/4 - 28			34048	*					15	48.706
5/16 - 18	33058	*							15	52.188
5/16 - 24			34058	*					15	52.188
3/8 - 16	33068	*							10	64.937
3/8 - 24			34068	*					10	64.937
7/16 - 14	33078	*							10	75.373
7/16 - 20			34088	*					10	83.494
1/2 - 13	33088	*							10	83.494
1/2 - 20			34088	*					10	83.494
9/16 - 12	33098								6	119.815
9/16 - 18			34098						6	114.112
5/8 - 11	33108								6	126.257
5/8 - 18			34108						6	126.257
11/16 - 11	33110								5	190.188
3/4 - 16			34128						5	199.701
3/4 - 10	33128								5	199.701
7/8 - 14							34140		5	233.134
7/8 - 9					33140				5	233.134
1" - 12							34160		5	288.350
1" - 8					33160				5	288.356
1" - 14							34160-14		5	300.621
1 1/8 - 7					33180				5	417.188
1 1/8 - 12							34180		5	417.188
1 1/4 - 7					33200				5	496.949
1 1/4 - 12							34200		5	496.949
1 3/8 - 6					33220				5	503.079
1 3/8 - 12							34220		5	503.079
1 1/2 - 6					33240				4	638.052
1 1/2 - 12							34240		4	638.052

* Drill and magnetic tangbreak tool included

Australian Price List Effective May 2013

Note! All prices are exclusive of GST



Thread Repair Kits Inch

BSW 32000+				
Size	Part No.		Inserts per Kit	Price per Kit
1/8 - 40	32028	*	15	73.43
3/16 - 24	32038	*	15	61.84
1/4 - 20	32048	*	15	57.97
5/16 - 18	32058	*	15	60.54
3/8 - 16	32068	*	10	74.72
7/16 - 14	32078	*	10	86.31
1/2 - 12	32088	*	10	94.05
9/16 - 12	32098		6	122.40
5/8 - 11	32108		6	131.41
3/4 - 10	32128		6	199.69
7/8 - 9	32140		6	231.90
1" - 8	32160		5	294.48
1 1/8 - 7	32180		5	429.45
1 1/4 - 7	32200		5	503.07
1 3/8 - 6	32220		5	521.49
1 1/2 - 6	32240		5	656.46

BSP 31000+				
Size	Part No.		Inserts per Kit	Price per Kit
1/8 - 28	31028	*	10	113.37
1/4 - 19	31048		10	150.73
3/8 - 19	31068		6	213.86
1/2 - 14	31080		5	651.38
5/8 - 14	31100		5	380.37
3/4 - 14	31120		5	423.32
1" - 11	31160		5	582.84

SPECIALS UNEF				
Size	Part No.		Inserts per Kit	Price per Kit
1/4 - 32	34040-32		10	79.76
7/16 - 24	34070-24		10	128.84
9/16 - 20	34090-20		5	110.43

* Drill and magnetic tangbreak tool included
 Australian Price List Effective May 2013
 Note! All prices are exclusive of GST

BSF 30000+				
Size	Part No.		Inserts per Kit	Price per Kit
3/16 - 32	30038	*	15	
1/4 - 26	30048	*	15	
5/16 - 22	30058	*	15	
3/8 - 20	30068	*	10	
7/16 - 18	30078	*	10	
1/2 - 16	30080	*	10	
9/16 - 16	30090		6	
5/8 - 14	30100		6	
3/4 - 12	30120		6	
7/8 - 11	30140		5	
1" - 10	30160		5	
1 1/4 - 9	30200		5	

BA 30500+				
Size	Part No.		Inserts per Kit	Price per Kit
O BA	30508	*	15	
2 BA	30528	*	15	
4 BA	30548	*	15	
6 BA	30568	*	15	

8 TPI UN 36180+				
Size	Part No.		Inserts per Kit	Price per Kit
1 1/8 - 8	36180		5	
1 1/4 - 8	36200		5	
1 3/8 - 8	36220		5	
1 1/2 - 8	36240		4	
1 5/8 - 8	36260		4	
1 3/4 - 8	36280		4	
1 7/8 - 8	36300		4	
2" - 8	36320		4	

CUMMINS-HEAD BOLT				
Size	Part No.		Inserts per Kit	Price per Kit
1 1/16 - 11	34110-16		10	239.27

BSC / BRASS 36000+				
Size	Part No.		Inserts per Kit	Price per Kit
5/16 - 26	36508	*	15	88.89
3/8 - 26	36608	*	10	96.62
7/16 - 26	36708	*	5	117.23
1/2 - 26	36808	*	5	128.84

NPT 36000+				
Size	Part No.		Inserts per Kit	Price per Kit
1/8 - 27	36028		10	141.71
1/4 - 18	36048		10	193.25
3/8 - 18	36068		6	270.56
1/2 - 14	36080		5	337.43
3/4 - 14	36128		5	98.16
1 - 11 1/2	36160		5	638.05

LEFT HAND THREAD KITS				
Size	Part No.		Inserts per Kit	Price per Kit
1/4 - 20	33048LH	*	15	245.40
5/16 - 18	33058LH	*	15	245.40
3/8 - 16	33068LH	*	10	245.40
7/16 - 14	33078LH	*	5	245.40
1/2 - 13	33088LH	*	5	245.40

HARLEY				
Size	Part No.		Inserts per Kit	Price per Kit
1/4 - 24	34048-24		10	79.75
7/16 - 16	34078-16		5	116.56

CARBURETTOR				
Size	Part No.		Inserts per Kit	Price per Kit
7/8 - 20	34140-20		5	337.43
1" - 20	34160-20		5	368.10
7/8 - 12	34140-12		5	429.45



Sparkplug/Plugsaver Kits - for thread strengthening or repair



SPARKPLUG 38000+					
Size	TRADE SERIES KIT Part No.	STD KIT Part No.	Description	Inserts per Kit	Price per Kit
M10 x 1	38108-2			10	106.93
M12 x 1.25	38120-2			10	123.68
M14 x 1.25*		38140	Contains 5 x 3/4", and 3/8" s/plug inserts & includes extracting tool in large tin	10	109.20
M14 x 1.25	38148-2		Contains 5 x 3/4", and 3/8" s/plug inserts	10	112.09
M18 x 1.5	38188		NB: Spark Plug kits contain pilot nose taps	4	127.61
SPARKPLUG METRIC M14 x 1.25		38147	Contains 3 x 8.4, 3 x 12.4 & 3 x 16.4mm inserts	4	127.61
EXHAUST ANALYSIS KIT		38188-1X	NB: This kit contains high temperature Inconel Inserts	5	219.02

Sparkplug kits contain a Pilot nose Tap.
No drilling is required.

PLUGSAVER 38000+ - An alternative method of thread repair for standard and taper seat plugs, using Thinwall inserts.		
Part No.	Description	Price per Kit
38148	COMPLETE REPAIR KIT	87.78
98142RP	SHORT REACH INSERT (PKT OF 5) 9.5MM	26.69
98143RP	MED. REACH INSERT (PKT OF 5) 12.7MM	31.65
98144RP	LONG REACH INSERT (PKT OF 5) 19MM	36.61
98145	PILOT TAP	60.74
98146	EXPANDING TOOL	14.11
98147RP	2 X 3/8", 2 X 1/2", 2 X 3/4" inserts	37.84
98140T	F250 KIT	147.21
98149RP	F250 REPAIR INSERTS (PACKET OF 5)	39.18

Australian Price List Effective May 2013
Note! All prices are exclusive of GST



Replacement Insert Packets for Kits and Merchandiser - Metric

Most inserts in replacement packets are 1.5 x Diameter. For example - M6 is 9mm Long, 1/4" is 3/8" long.

Coarse 25000+				Medium 27000+				Extra Fine 28000+			
Metric Thread	Part No.	Ins/ Pkt	Price/ Pkts \$	Metric Thread	Part No.	Ins/ Pkt	Price/ Pkts \$	Metric Thread	Part No.	Ins/ Pkt	Price/ Pkts \$
M2 x 0.4 x 1D	25022	10	8.43								
M2 x 0.4 x 1.5D	25023	10	9.27								
M2 x 0.4 x 2D	25024	10	9.84								
M2 x 2 x 0.45 x 1.5D	25013	10	8.15								
M2 x 5 x 0.45 x 1D	25252	10	6.89								
M2.5 x 0.45 x 1.5D	25253	10	7.32								
M2.5 x 0.45 x 2D	25254	10	7.72								
M3 x 0.5 x 1D	25032	10	6.89								
M3 x 0.5 x 1.5D	25033	10	7.32								
M3 x 0.5 x 2D	25034	10	7.72								
M3.5 x 0.6 x 1.5D	25353	10	7.87								
M4 x 0.7 x 1D	25042	10	6.89								
M4 x 0.7 x 1.5D	25043	10	7.32								
M4 x 0.7 x 2D	25044	10	7.72								
M5 x 0.8 x 1D	25052	10	6.89								
M5 x 0.8 x 1.5D	25053	10	7.32								
M5 x 0.8 x 2D	25054	10	7.72								
M6 x 1 x 1D	25062	10	7.54								
M6 x 1 x 1.5D	25063	10	8.27								
M6 x 1 x 2D	25064	10	8.72								
M6 x 1.0 x 2.5D	25064	10	8.72								
M7 x 1 x 1.D	25072	10	7.72								
M7 x 1 x 1.5D	25073	10	9.04								
M7 x 1 x 2.D	25074	10	9.96								
M8 x 1.25 x 1D	25082	10	7.97	M8 x 1 x 1D	27082	10	7.97				
M8 x 1.25 x 1.5D	25083	10	9.04	M8 x 1 x 1.5D	27083	10	9.04				
M8 x 1.25 x 2D	25084	10	9.96	M8 x 1 x 2.D	27084	10	9.96				
M8 x 1.25 x 2.5D	25085	10	12.38								
M9 x 1.25 x 1.5D	25093	10	12.70	M9 x 1 x 1.5D	27093	10	12.70				
M10 x 1.5 x 1D	25102	10	11.23	M10 x 1.25 x 1.D	27102	10	11.23				
M10 x 1.5 x 1.5D	25103	10	12.70	M10 x 1.25 x 1.5D	27103	10	12.70				
M10 x 1.5 x 2D	25104	10	14.49	M10 x 1.25 x 2D	27104	10	14.48				
M10 x 1.5 x 2.5D	25105	10	17.44	M10 x 1.25 x 3D	27106	10	20.69				
M11 x 1.5 x 1D	25112	10	16.40	M11 x 1.25 x 1.5D	27113	10	17.73	M11 x 1 x 1.5D	28113	10	17.73
M11 x 1.5 x 1.5D	25113	10	17.73								
M12 x 1.75 x 1D	25122	10	16.40	M12 x 1.5 x 1.D	27122	10	16.40	M12 x 1.25 x 1D	28122	10	16.40
M12 x 1.75 x 1.5D	25123	10	17.73	M12 x 1.5 x 1.5D	27123	10	17.73	M12 x 1.25 x 1.5D	28123	10	17.73
M12 x 1.75 x 2D	25124	10	20.69	M12 x 1.5 x 2D	27124	10	20.69	M12 x 1.25 x 2D	28124	10	20.69
M13 x 1.75 x 1.5D	25133	5	21.06	M13 x 1.5 x 1.5D	27133	5	21.07	M13 x 1.25 x 1.5D	28133	10	21.06
M14 x 2 x 1D	25142	5	10.94	M14 x 1.5 x 1.5D	27143	5	14.04				
M14 x 2 x 1.5D	25143	5	14.04	M14 x 1.5 x 2D	27144	5	17.55				
M14 x 2 x 2D	25144	5	17.55								
M15 x 2 x 1.5D	25153	5	17.29	M15 x 1.5 x 1.5D	27153	5	17.29				
M16 x 2 x 1D	25162	5	14.03	M16 x 1.5 x 1D	27162	5	14.03				
M16 x 2 x 1.5D	25163	5	17.29	M16 x 1.5 x 1.5D	27163	5	17.29				
M16 x 2 x 2D	25164	5	22.16	M16 x 1.5 x 2.5D	27165	5	26.60				
M16 x 2 x 2.5D	25165	5	26.60								
M18 x 2.5 x 1D	25182	5	20.08								
M18 x 2.5 x 1.5D	25183	5	23.64	M18 x 2 x 1.5D	27183	5	23.64	M18 x 1.5 x 1.5D	28183	5	23.64
M20 x 2.5 x 1.5D	25203	5	32.52	M20 x 2 x 1.5D	27203	5	32.52	M20 x 1.5 x 1.5D	28203	5	32.52
M22 x 2.5 x 1.5D	25223	3	24.38	M22 x 2 x 1.5D	27223	3	24.38	M22 x 1.5 x 1.5D	28223	3	24.38
M24 x 3 x 1.5D	25243	3	30.16	M24 x 2 x 1.5D	27243	3	30.15	M24 x 1.5 x 1.5D	28243	3	30.15
								M26 x 1.5 x 1.5D	28263	1	15.16
M30 x 3.5 x 1.5D	25303	1	16.85								

Australian Price List Effective May 2013. Note! All prices are exclusive of GST

Replacement Insert Packets for Kits and Merchandiser - Inch

UNC Thread Size	Part No.	23000+ Ins/Pkt	Price/Pkts \$
#2 - 56 x 1D	23522	10	8.87
#2 - 56 x 1.5D	23523	10	9.61
#3 - 48 x 1.5D	23533	10	15.97
#4 - 40 x 1D	23542	10	6.80
#4 - 40 x 1.5D	23543	10	7.25
#4 - 40 x 2D	23544	10	7.69
#5 - 40 x 1D	23552	10	6.80
#5 - 40 x 1.5D	23553	10	7.25
#5 - 40 x 2D	23554	10	7.69
#6 - 32 x 1D	23562	10	6.80
#6 - 32 x 1.5D	23563	10	7.25
#6 - 32 x 2D	23564	10	7.69
#8 - 32 x 1D	23582	10	6.80
#8 - 32 x 1.5D	23583	10	7.25
#8 - 32 x 2D	23584	10	7.69
#10 - 24 x 1D	23602	10	6.80
#10 - 24 x 1.5D	23603	10	7.25
#10 - 24 x 2D	23604	10	7.69
#12 - 24 x 1D	23622	10	7.84
#12 - 24 x 1.5D	23623	10	8.13
1/4 - 20 x 1D	23042	10	7.84
1/4 - 20 x 1.5D	23043	10	8.13
1/4 - 20 x 2D	23044	10	9.16
5/16 - 18 x 1D	23052	10	8.58
5/16 - 18 x 1.5D	23053	10	9.02
5/16 - 18 x 2D	23054	10	9.91
3/8 - 16 x 1D	23062	10	11.53
3/8 - 16 x 1.5D	23063	10	12.71
3/8 - 16 x 2D	23064	10	14.78
7/16 - 14 x 1D	23072	10	14.19
7/16 - 14 x 1.5D	23073	10	15.07
7/16 - 14 x 2D	23074	10	16.86
1/2 - 13 x 1D	23082	10	16.25
1/2 - 13 x 1.5D	23083	10	17.50
1/2 - 13 x 2D	23084	10	19.52
9/16 - 12 x 1D	23092	5	10.34
9/16 - 12 x 1.5D	23093	5	11.82
5/8 - 11 x 1D	23102	5	13.89
5/8 - 11 x 1.5D	23103	5	17.00
11/16 - 11 x 1.5D	23113	5	22.47
3/4 - 10 x 1D	23122	5	19.94
3/4 - 10 x 1.5D	23123	5	23.64
7/8 - 9 x 1.5D	23143	3	23.95
1" - 8 x 1.5D	23163	3	30.16
1 1/8 - 7 x 1D	23182	1	14.03
1 1/8 - 7 x 1.5D	23183	1	14.78
1 1/4 - 7 x 1D	23202	1	15.44
1 1/4 - 7 x 1.5D	23203	1	16.86
1 3/8 - 6 x 1.5D	23223	1	17.73
1 1/2 - 6 x 1D	23242	1	19.66
1 1/2 - 6 x 1.5D	23243	1	23.64

UNF Thread Size	Part No.	24000+ Ins/Pkt	Price/Pkts \$
#3 - 56 x 1.5D	24533	10	15.97
#4 - 48 x 1.5D	24543	10	7.25
#6 - 40 x 1D	24562	10	6.80
#6 - 40 x 1.5D	24563	10	7.25
#8 - 36 x 1.5D	24583	10	7.25
#10 - 32 x 1D	24602	10	6.80
#10 - 32 x 1.5D	24603	10	7.25
#10 - 32 x 2D	24604	10	7.69
#12 - 28 x 1.5D	24623	10	8.13
1/4 - 28 x 1D	24042	10	7.84
1/4 - 28 x 1.5D	24043	10	8.13
1/4 - 28 x 2D	24044	10	9.16
5/16 - 24 x 1D	24052	10	8.58
5/16 - 24 x 1.5D	24053	10	9.02
5/16 - 24 x 2D	24054	10	9.91
3/8 - 24 x 1D	24062	10	11.53
3/8 - 24 x 1.5D	24063	10	12.71
3/8 - 24 x 2D	24064	10	14.78
7/16 - 20 x 1D	24072	10	14.19
7/16 - 20 x 1.5D	24073	10	15.07
7/16 - 20 x 2D	24074	10	16.86
1/2 - 20 x 1D	24082	10	16.25
1/2 - 20 x 1.5D	24083	10	17.50
1/2 - 20 x 2D	24084	10	19.52
9/16 - 18 x 1D	24092	5	10.34
9/16 - 18 x 1.5D	24093	5	11.82
5/8 - 18 x 1D	24102	5	13.89
5/8 - 18 x 1.5D	24103	5	17.00
3/4 - 16 x 1D	24122	5	19.94
3/4 - 16 x 1.5D	24123	5	23.58
7/8 - 14 x 1.5D	24143	3	23.64
1" - 12 x 1.5D	24163	3	30.16
1 1/8 - 12 x 1D	24182	1	14.03
1 1/8 - 12 x 1.5D	24183	1	14.78
1 1/4 - 12 x 1D	24202	1	15.44
1 1/4 - 12 x 1.5D	24203	1	16.86
1 3/8 - 12 x 1.5D	24223	1	17.73
1 1/2 - 12 x 1D	24242	1	19.65
1 1/2 - 12 x 1.5D	24243	1	23.64



Australian Price List Effective May 2013
Note! All prices are exclusive of GST

Replacement Insert Packets for Kits and Merchandiser - Inch

BSF		20000+	
Thread Size	Part No.	Ins/ Pkt	Price/ Pkts \$
3/16 - 32 x 1D	20032	10	6.85
3/16 - 32 x 1.5D	20033	10	7.30
3/16 - 32 x 2D	20034	10	7.72
5/16 - 22 x 1.5D	20052	10	7.97
5/16 - 22 x 1D	20053	10	9.16
5/16 - 22 x 2D	20054	10	10.93
3/8 - 20 x 1D	20062	10	11.23
3/8 - 20 x 1.5D	20063	10	12.70
3/8 - 20 x 2D	20064	10	14.49
7/16 - 18 x 1D	20072	10	13.88
7/16 - 18 x 1.5D	20073	10	15.07
7/16 - 18 x 2D	20074	10	16.55
1/2 - 16 x 1D	20082	10	16.40
1/2 - 16 x 1.5D	20083	10	17.50
1/2 - 16 x 2D	20084	10	20.69
9/16 - 16 x 1.5D	20093	5	11.82
5/8 - 14 x 1.5D	20103	5	17.73
3/4 - 12 x 1.5D	20123	5	23.64
7/8 - 11 x 1.5D	20143	5	23.94
1" - 10 x 1.5D	20163	5	30.16

BA		20500+	
Thread Size	Part No.	Ins/ Pkt	Price/ Pkts \$
OBA x 1.5D	20503	10	13.00
2BA x 1.5D	20523	10	13.00
4BA x 1.5D	20543	10	13.00
6BA x 1.5D	20563	10	13.00

SPARKPLUG		28000+	
Thread Size	Part No.	Ins/ Pkt	Price/ Pkts \$
M10 x 1 x 1D	28102	10	11.24
M10 x 1 x 1.5D	28103	10	12.71
M10 x 1 x 2D	28104	10	14.49
M10 x 1 x 6.8mm	28107	10	12.27
M10 x 1 x .339"	28108	10	11.47
M10 x 1 x 1/2"	28109	10	13.00
M14 x 1.25 x 3/4"	28140	10	19.62
M14 x 1.25 x 7/16"	28147	10	12.52
M14 x 1.25 x 3/8"	28148	10	9.80
M14 x 1.25 x 1/2"	28149	10	14.93
M18 x 1.5 x 1/2"	28189	5	13.89

BSP		21000+	
Thread Size	Part No.	Ins/ Pkt	Price/ Pkts \$
1/8 - 28 x 1D	21022	10	16.55
1/8 - 28 x 1.5D	21023	10	19.39
1/8 - 28 x 12D	21024	10	26.01
1/4 - 19 x 1D	21042	10	23.64
1/4 - 19 x 1.5D	21043	10	28.37
1/4 - 19 x 2D	21044	10	37.83
3/8 - 19 x 1D	21062	10	26.01
3/8 - 19 x 1.5D	21063	10	35.47
3/8 - 19 x 2D	21064	10	49.66
1/2 - 14 x 1.5D	21082	5	23.06
1/2 - 14 x 1.5D	21083	5	28.97
1/2 - 14 x 1.5D	21084	5	37.83
3/4 - 14 x 1.5D	21123	5	42.56
1" - 11 x 1.5D	21163	3	33.70

NPT		26000+	
Thread Size	Part No.	Ins/ Pkt	Price/ Pkts \$
1/8 - 27 x 1.5D	26023	10	19.39
1/4 - 18 x 1.5D	26043	10	28.37
3/8 - 18 x .407D	26063	10	35.47
1/2 - 14 x 1.5D	26083	5	28.97
3/4 - 14 x .553D	26123	5	42.56
1 - 11 1/2 x 1.65D	26163	3	33.70

BICYCLE DERAILLEUR KIT			
Thread Size	Part No.	Ins/ Pkt	Price/ Pkts \$
M10 x 1 x 6.8	28107	10	12.27

BICYCLE CRANK KIT			
Thread Size	Part No.	Ins/ Pkt	Price/ Pkts \$
9/16 - 20 x 1/2	24090-20	10	11.38
	24090-20LH	10	11.38

BSW		22000+	
Thread Size	Part No.	Ins/ Pkt	Price/ Pkts \$
1/8 - 40 x 1.5D	22023	10	8.27
3/16 - 24 x 1.5D	22033	10	7.30
1/4 - 20 x 1.5D	22043	10	8.13
5/16 - 18 x 1.5D	22053	10	9.16
3/8 - 16 x 1.5D	22063	10	12.70
7/16 - 14 x 1.5D	22073	10	15.07
1/2 - 12 x 1D	22082	10	16.40
1/2 - 12 x 1.5D	22083	10	17.44
1/2 - 12 x 2D	22084	10	20.69
9/16 - 12 x 1.5D	22093	5	11.82
5/8 - 11 x 1.5D	22103	5	17.73
3/4 - 10 x 1.5D	22123	5	23.64
7/8 - 9 x 1.5D	22143	3	23.94
1" - 8 x 1.5D	22163	3	30.16

BSC		26500+	
Thread Size	Part No.	Ins/ Pkt	Price/ Pkts \$
5/16 - 26 x 1.5D	26503	10	14.66
3/8 - 26 x 1.5D	26603	10	17.02
7/16 - 26 x 1.5D	26703	10	23.64
1/2 - 26 x 1.5D	26803	10	37.83

EXHAUST ANALYSIS 28000+				
Thread Size	Part No.	Length	Ins/ Pkt	Price/ Pkts \$
M18 x 1.5	28181X	12.5	5	5.91

NB: This pkt contains 5 high temperature Inconel Inserts

Australian Price List Effective May 2013
Note! All prices are exclusive of GST



Range Kits

Recoil range kit contains a selection of Recoils most popular sizes. It provides you with an all in one workshop solution for Multi Diameter thread repairs. It's ideal for garages and other workshops where thread repairs are often undertaken.

Standard Kit Content*

- High speed steel (HSS) intermediate STI taps
- Quantity of inserts 1.5D length
- New Combo Tap Drive and Installation Tool*
- New Magnetic Tang Break Tool*
- Drill-bit*

* Kit contents differ depending on thread form and diameters



POPULAR SIZES				
THREAD/TYPE	PART NO.	INCLUDES	Price per Kit	Sizes per Kit
UNC	33004R	1/4, 5/16, 3/8, 7/16, 1/2	324.67	5
UNF	34004R	1/4, 5/16, 3/8, 7/16, 1/2	330.47	5
METRIC	35003R	M4, 5, 6, 8-1.25,10-1.5	276.55	5
METRIC	35004R	M5, 6, 8-1.25,10-1.5,12-1.75	276.55	5
METRIC	35005R	M6, 8-1.25,10-1.5,12-1.75,16-2	381.49	5

INCH				
THREAD/TYPE	PART No.	INCLUDES	Price per Kit	Sizes per Kit
BSF	30004R	1/4, 5/16, 3/8, 7/16, 1/2	464.98	5
BSP	31004R	1/8, 1/4, 3/8	691.08	3
BSW	32004R	1/4, 5/16, 3/8, 7/16, 1/2	346.69	5
UNC	33002R	4-40, 6-32, 8-32, 10-24UNC & 10-32UNF	279.39	5
BSC/BRASS	36001R	1/4, 5/16, 3/8, 7/16, 1/2	464.98	5
NPT	36004R	1/8, 1/4, 3/8, 1/2	484.76	4

INCH - MINI RANGE KIT				
THREAD/TYPE	PART No.	INCLUDES	Price per Kit	Sizes per Kit
UNC	33001R	1/4, 5/16, 3/8	147.59	3
HARLEY	34008R	1/4-24 & 7/16-16 Harley, 3/8-20 BSF	259.52	3
UNF	34001R	1/4, 5/16, 3/8	157.92	3

METRIC				
THREAD/TYPE	PART No.	INCLUDES	Price per Kit	Sizes per Kit
METRIC	33005R	M6, 8-1.25, 10-1.5, 12-1.75, 14-1.25PN	381.49	5
METRIC	33007R	M4, 5, 6, 8-1.25	316.14	4
FINE	37000R	M8-1,10-1,10-1.25,12-1.25,12-1.5	398.88	5
METRIC	37003R	M6, 8-1.25, 10-1.5, 12-1.75, 14-2	365.25	5
METRIC	37004R	M4, 6, 8-1.25, 10-1.5, 12-1.75	316.56	5
M/CYCLE	38006R	M6, 8-1.25, 10-1.25, 12-1.25PN, 14-1.25PN	390.76	5
OPE	38007R	M5, 6, 8-1.25, 14-1.25PN, 1/4-20	350.18	5

BICYCLE CRANK & DERAILER				
THREAD/TYPE	PART No.	INCLUDES	Price per Kit	Sizes per Kit
CRANK KIT	34096-20	1 EACH - LEFT & RIGHT HAND	220.00	2
		5 - 9/16-20X1/2" LEFT HAND INSERTS		
		5 - 9/16-20X1/2" RIGHT HAND INSERTS		
		1 - INSTALLATION TOOL		
DERAILLEUR KIT	38102	THREAD KIT M10-1X6.8	75.77	1
BICYCLE RANGE	34005	9/16-20 RH & LH, M10-1 Derailleur	183.99	3

Australian Price List Effective May 2013

Note! All prices are exclusive of GST

Re-Grip / Plugsaver / Gauges / Drill-Out / X-Out

RE-GRIP - Friction Enhancing Compound		
Part No.	Size	Price/Pkts \$
11111	15ml tube on backing card	8.79
PITCH/TPI GAUGES		
Part No.	Size	Price/Pkts \$
65000	Metric	18.79
63000	Inch	18.79
69000	1 each Metric and Inch set	32.60
POWER EXTRACTORS - For removal broken Bolts, studs and screws		
DRILL OUT - Power extractor for broken Bolts or studs		
Part No.	Size	Price/Pkts \$
Micro Drill-Out Power Extractors		
P125	#5, #6 * M3	24.03
P164	#8 & M4	26.08
P190	#10, #12 & M5	28.07
P236	1/4" & M6	30.11
P250	1/4" or 6mm	30.11
P312	5/16" or 8mm	33.10
P375	3/8" or 10mm	36.14
P500	1/2" or 12mm	42.16
Drill-Out Range Kits		
P450	Kit comprising P125, P164, P190, P230	90.34
P401	Kit comprises P250, P312, P375, P500	120.51
P701	Kit Comprises P125, P164, P190, P236, P312, P375, P500	168.74
X-OUT - Extractors for removing all types of screws		
Part No.	Size	Price/Pkts \$
2019P8001	Set of 3 X-Outs Removes # 8 to # 14 screws	50.17
2001P8001	Single X-Out Removes # 6 to # 8 screws	22.05
2003P8001	Single X-Out Removes # 10 to # 14 screws	24.03

Australian Price List Effective May 2013
 Note! All prices are exclusive of GST



Re - Grip



Thread Pitch Gauges



Drill - Out



X - Out

Tangless Inserts

Tangless® Inserts:

- FOD-Free Design: No tangs to break off, retrieve...or lose.
- Approved for use on military programs by NASM8846 and NAS1130.
- Cost Reduction: Significantly decreased installation and inspection time.
- Bi-directional design eliminates insert orientation requirement.
- Quick, non-destructive removal prevents damage to castings.



Metric Tangless CoilThread Inserts are made of cold-rolled Type 304 stainless steel wire (AS7245 and MA1565), work-hardened to a tensile strength above 200,000 psi, a hardness of Rc 43-50 and an exceedingly smooth (8-16 micro-inches) surface finish. Metric Tangless Inserts are designed to replace tanged helical coil inserts as specified in MA3279 through MA3281 (standard thread) and MA3329 through MA3331 (locking thread). They install in standard STI tapped holes per MA1567. Installed inserts provide a finished thread meeting the requirements of FED-STD-H28, M Profile, Tolerance Classes 4H or 5H, as well as ISO metric thread specifications, and accept standard or MJ profile bolts or screws.

Tangless - Metric Free Running Series								
Thread Nominal	Nominal Length	Recoil Part No.	Price \$ each per Insert (1000+)	Price \$ each per Insert (5000+)	Free Coil Dia Min /Max.	Number of Coils	Length (mm)	KATO Part No.
M2.5 x 0.45	1D	TL05252	0.46	0.34		3.375	2.5	2TNM2.5x.45C-2.5
	1.5D	TL05253	0.49	0.36	3.20	5.625	3.75	2TNM2.5x.45C-3.8
	2D	TL05254	0.51	0.38	3.70	8	5	2TNM2.5x.45C-5
	2.5D	TL05255	0.56	0.42		10.5	6.25	2TNM2.5x.45C-6.3
	3D	TL05256	0.61	0.45		12.750	7.5	2TNM2.5x.45C-7.5
M3 x 0.5	1D	TL05032	0.41	0.31		3.75	3	2TNM3x.5C-3
	1.5D	TL05033	0.44	0.33	3.80	6.375	4.5	2TNM3x.5C-4.5
	2D	TL05034	0.46	0.34	4.35	8.875	6	2TNM3x.5C-6
	2.5D	TL05035	0.50	0.38		11.375	7.5	2TNM3x.5C-7.5
	3D	TL05036	0.56	0.42		13.875	9.0	2TNM3x.5C-9
M4 x 0.7	1D	TL05042	0.41	0.31		3.625	4	2TNM4x.7C-4
	1.5D	TL05043	0.44	0.33	5.05	6.125	6	2TNM4x.7C-6
	2D	TL05044	0.46	0.34	5.60	8.625	8	2TNM4x.7C-8
	2.5D	TL05045	0.50	0.38		11.125	10	2TNM4x.7C-10
	3D	TL05046	0.56	0.42		13.625	12	2TNM4x.7C-12
M5 x 0.8	1D	TL05052	0.41	0.31		4.125	5	2TNM5x.8C-5
	1.5D	TL05053	0.44	0.33	6.20	6.875	7.5	2TNM5x.8C-7.5
	2D	TL05054	0.46	0.34	6.80	9.625	10	2TNM5x.8C-10
	2.5D	TL05055	0.52	0.39		12.375	12.5	2TNM5x.8C-12.5
	3D	TL05056	0.59	0.44		15.125	15	2TNM5x.8C-15
M6 x 1	1D	TL05062	0.45	0.34		4.00	6	2TNM6x1C-6
	1.5D	TL05063	0.50	0.38	7.40	6.75	9	2TNM6x1C-9
	2D	TL05064	0.52	0.39	7.95	9.50	12	2TNM6x1C-12
	2.5D	TL05065	0.57	0.42		12.125	15	2TNM6x1C-15
	3D	TL05066	0.62	0.47		14.875	18	2TNM6x1C-18

Thread Nominal	Nominal Length	Recoil Part No.	Price \$ each per Insert (500+)	Price \$ each per Insert (5000+)	Free Coil Dia Min /Max.	Number of Coils	Length (mm)	KATO Part No.
M8 x 1.25	1D	TL05082	0.48	0.36		4.500	10	2TNM8x1.25C-8
	1.5D	TL05083	0.54	0.41	9.80	7.375	12	2TNM8x1.25C-12
	2D	TL05084	0.60	0.45	10.35	10.250	16	2TNM8x1.25C-16
	2.5D	TL05085	0.74	0.56		13.250	18	2TNM8x1.25C-20
	3D	TL05086	0.89	0.67		16.125	20	2TNM8x1.25C-24
M10 x 1.5	1D	TL05102	0.67	0.50		4.9	10	2TNM10x1.5C-10
	1.5D	TL05103	0.76	0.58	11.95	8.000	15	2TNM10x1.5C-15
	2D	TL05104	0.87	0.66	12.50	11.1	20	2TNM10x1.5C-20
	2.5D	TL05105	1.05	0.78		14.250	25	2TNM10x1.5C-25
	3D	TL05106	1.24	0.94		17.375	30	2TNM10x1.5C-30

Australian Price List Effective May 2013
Note! All prices are exclusive of GST

Tangless Inserts - Screw Locking

Thread Nominal	Nominal Length	Recoil Part No.	Price \$ each per Insert 1000+	Price \$ each per Insert 5000+	Free Coil Dia Min /Max.	Number of Coils	Length (mm)	KATO Part No.
M2.5 x 0.45	1D	TL15252	Upon Request	Upon Request		3.375	2.5	2TLM2.5x.45C-2.5
	1.5D	TL15253			3.20	5.625	3.75	2TLM2.5x.45C-3.8
	2D	TL15254			3.70	8	5	2TLM2.5x.45C-5
	2.5D	TL15255				10.5	6.25	2TLM2.5x.45C-6.3
	3D	TL15256				12.750	7.5	2TLM2.5x.45C-7.5
M3 x 0.5	1D	TL15032	0.50	0.38		3.75	3	2TLM3x0.5C-3
	1.5D	TL15033	0.53	0.39	3.80	6.375	4.5	2TLM3x0.5C-4.5
	2D	TL15034	0.56	0.41	4.35	8.875	6	2TLM3x0.5C-6
	2.5D	TL15035	0.60	0.45		11.375	7.5	2TLM3x0.5C-7.5
	3D	TL15036	0.67	0.51		13.875	9.0	2TLM3x0.5C-9
M4 x 0.7	1D	TL15042	0.50	0.38		3.625	4	2TLM4x0.7C-4
	1.5D	TL15043	0.53	0.39	5.05	6.125	6	2TLM4x0.7C-6
	2D	TL15044	0.56	0.41	5.60	8.625	8	2TLM4x0.7C-8
	2.5D	TL15045	0.60	0.45		11.125	10	2TLM4x0.7C-10
	3D	TL15046	0.67	0.51		13.625	12	2TLM4x0.7C-12
M5 x 0.8	1D	TL15052	0.50	0.38		4.125	5	2TLM5x0.8C-5
	1.5D	TL15053	0.53	0.39	6.20	6.875	7.5	2TLM -5x.8C-7.5
	2D	TL15054	0.56	0.41	6.80	9.625	10	2TLM5x0.8C-10
	2.5D	TL15055	0.63	0.47		12.375	12.5	2TLM5x0.8C-12.5
	3D	TL15056	0.71	0.53		15.125	15	2TLM5x0.8C-15
M6 x 1	1D	TL15062	0.54	0.41		4.00	6	2TLM6x1C-6
	1.5D	TL15063	0.60	0.45	7.40	6.75	9	2TLM6x1C-9
	2D	TL15064	Upon Request	0.47	7.95	9.50	12	2TLM6x1C-12
	2.5D	TL15065	0.68	0.51		12.125	15	2TLM6x1C-15
	3D	TL15066	0.75	0.56		14.875	18	2TLM6x1C-18

Thread Nominal	Nominal Length	Recoil Part No.	Price \$ each per Insert (500+)	Price \$ each per Insert (5000+)	Free Coil Dia Min /Max.	Number of Coils	Length mm	KATO Part No.
M8 x 1.25	1D	TL15082	0.57	0.43		4.500	10	2TLM8x1.25C-8
	1.5D	TL15083	0.65	0.49	9.80	7.375	12	2TLM8x1.25C-12
	2D	TL15084	0.72	0.54	10.35	10.250	16	2TLM8x1.25C-16
	2.5D	TL15085	0.89	0.68		13.250	18	2TLM8x1.25C-20
	3D	TL15086	1.06	0.81		16.125	20	2TLM8x1.25C-24
M10 x 1.5	1D	TL15102	0.81	0.60		4.9	10	2TLM10x1.5C-10
	1.5D	TL15103	0.92	0.69	11.95	8.000	15	2TLM10x1.5C-15
	2D	TL15104	1.04	0.79	12.50	11.1	20	2TLM10x1.5C-20
	2.5D	TL15105	1.26	0.94		14.250	25	2TLM10x1.5C-25
	3D	TL15106	1.49	1.13		17.375	30	2TLM10x1.5C-30

Tangless Inserts - Tooling



Hex Shank Insertion Tool

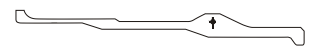

Replacement Pawl

HEX SHANK INSERTION TOOL - FREE RUNNING			
Size	Recoil Part No.	Kato Part No.	Price \$
M2.5 x 0.45	2CT10-M2.5F	2CT10-M2.5F	\$329.69
M3 x 0.5	2CT10-M3F	2CT10-M3F	\$329.69
M4 x 0.7	2CT10-M4F	2CT10-M4F	\$329.69
M5 x 0.8	2CT10-M5F	2CT10-M5F	\$329.69
M6 x 1	2CT10-M6F	2CT10-M6F	\$329.69
M8 x 1.25	2CT10-M8F	2CT10-M8F	\$377.12
M10 x 1.5	2CT10-M10F	2CT10-M10F	\$377.12
M12 x 1.75	2CT10-M12F	2CT10-M12F	\$377.12

HEX SHANK INSERTION TOOL - LOCKING			
Size	Recoil Part No.	Kato Part No.	Price \$
M2.5 x 0.45	2CT10-M2.5L	2CT10-M2.5L	\$329.69
M3 x 0.5	2CT10-M3L	2CT10-M3L	\$329.69
M4 x 0.7	2CT10-M4L	2CT10-M4L	\$329.69
M5 x 0.8	2CT10-M5L	2CT10-M5L	\$329.69
M6 x 1	2CT10-M6L	2CT10-M6L	\$329.69
M8 x 1.25	2CT10-M8L	2CT10-M8L	\$377.12
M10 x 1.5	2CT10-M10L	2CT10-M10L	\$377.12
M12 x 1.75	2CT10-M12L	2CT10-M12L	\$377.12

REPLACEMENT PAWL			
Size	Recoil Part No.	Kato Part No.	Price \$
M2.5 x 0.45	2CT10-M2.5P	2CT20-M2.5	\$130.31
M3 x 0.5	2CT10-M3P	2CT20-M3	\$130.31
M4 x 0.7	2CT10-M4P	2CT20-M4	\$130.31
M5 x 0.8	2CT10-M5P	2CT20-M5	\$130.31
M6 x 1	2CT10-M6P	2CT20-M6	\$130.31
M8 x 1.25	2CT10-M8P	2CT20-M8	\$156.38
M10 x 1.5	2CT10-M10P	2CT20-M10	\$156.38
M12 x 1.75	2CT10-M12P	2CT20-M12	\$156.38

Australian Price List Effective May 2013
Note! All prices are exclusive of GST

Bulk Inserts Free Running - Metric

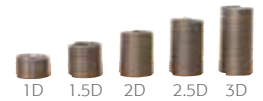

METRIC COARSE		INSTALLED LENGTH			METRIC FINE		PRICE EACH PER INSERT (100 PER BAG)				
Thread	Part No.	inches	mm	Dia	Part No.	POA	100+	500+	1000+	5000+	
M2 x 0.4	05022	0.079	2.0	1D			0.590	0.422	0.337	0.250	
	05023	0.118	3.0	1.5D			0.651	0.465	0.371	0.281	
	05024	0.157	4.0	2D			0.689	0.493	0.393	0.292	
	05025	0.197	5.0	2.5D			0.787	0.561	0.449	0.334	
	05026	0.236	6.0	3D			0.983	0.703	0.561	0.417	
M2.2 x 0.45	05012	0.087	2.2	1D			0.533	0.382	0.304	0.229	
	05013	0.13	3.3	1.5D			0.571	0.408	0.326	0.240	
	05014	0.173	4.4	2D			0.590	0.422	0.337	0.250	
	05015	0.217	5.5	2.5D		POA	0.651	0.465	0.371	0.281	
	05016	0.26	6.6	3D		POA	0.708	0.506	0.404	0.302	
M2.5 x 0.45	05252	0.098	2.5	1D			0.483	0.345	0.275	0.209	
	05253	0.15	3.8	1.5D			0.513	0.367	0.293	0.219	
	05254	0.197	5.0	2D			0.540	0.387	0.309	0.229	
	05255	0.248	6.3	2.5D			0.579	0.415	0.332	0.250	
	05256	0.295	7.5	3D			0.651	0.465	0.371	0.281	
M3 x 0.5	05032	0.118	3.0	1D			0.483	0.345	0.275	0.209	
	05033	0.177	4.5	1.5D			0.513	0.367	0.293	0.219	
	05034	0.236	6.0	2D			0.540	0.387	0.309	0.229	
	05035	0.295	7.5	2.5D			0.579	0.415	0.332	0.250	
	05036	0.354	9.0	3D			0.651	0.465	0.371	0.281	
M3.5 x 0.6	05352	0.138	3.5	1D			0.512	0.366	0.292	0.219	
	05353	0.209	5.3	1.5D			0.551	0.393	0.315	0.240	
	05354	0.276	7.0	2D			0.590	0.422	0.337	0.250	
	05355	0.346	8.8	2.5D		POA	0.651	0.465	0.371	0.281	
	05356	0.413	10.5	3D		POA	0.708	0.506	0.404	0.302	
M4 x 0.7	05042	0.157	4.0	1D			0.483	0.345	0.275	0.209	
	05043	0.236	6.0	1.5D			0.513	0.367	0.293	0.219	
	05044	0.315	8.0	2D			0.540	0.387	0.309	0.229	
	05045	0.394	10.0	2.5D			0.579	0.415	0.332	0.250	
	05046	0.472	12.0	3D			0.651	0.465	0.371	0.281	
M5 x 0.8	05052	0.197	5.0	1D			0.483	0.345	0.275	0.209	
	05053	0.295	7.5	1.5D			0.513	0.367	0.293	0.219	
	05054	0.394	10.0	2D			0.540	0.387	0.309	0.229	
	05055	0.492	12.5	2.5D			0.611	0.437	0.349	0.261	
	05056	0.591	15.0	3D			0.689	0.493	0.393	0.292	
M6 x 1	05062	0.236	6.0	1D			0.529	0.376	0.301	0.229	
	05063	0.354	9.0	1.5D			0.579	0.415	0.332	0.250	
	05064	0.472	12.0	2D			0.611	0.437	0.349	0.261	
	05065	0.591	15.0	2.5D			0.662	0.473	0.378	0.281	
	05066	0.709	18.0	3D			0.725	0.518	0.415	0.313	
M7 x 1	05072	0.276	7.0	1D			0.540	0.387	0.309	0.229	
	05073	0.413	10.5	1.5D			0.634	0.453	0.362	0.271	
	05074	0.551	14.0	2D			0.697	0.499	0.399	0.302	
	05075	0.689	17.5	2.5D			0.867	0.620	0.495	0.375	
	05076	0.827	21.0	3D			1.034	0.739	0.591	0.448	
M8 x 1.25	05082	0.945	24.0	3D	M8 x 1	07082	0.559	0.400	0.319	0.240	
	05083	0.472	12.0	1.5D		07083	0.634	0.453	0.362	0.271	
	05084	0.63	16.0	2D		07084	0.697	0.499	0.399	0.302	
	05085	0.787	20.0	2.5D		07085	0.867	0.620	0.495	0.375	
	05086	0.945	24.0	3D		07086	1.034	0.739	0.591	0.448	
		0.945	24.0	3			0.559	0.400	0.319	0.240	
		0.472	12.0	1.5			0.634	0.453	0.362	0.271	
		0.63	16.0	2			0.697	0.499	0.399	0.302	
		0.787	20.0	2/5			0.867	0.620	0.495	0.375	
		0.945	24.0	3			1.034	0.739	0.591	0.448	

Bulk Inserts Free Running - Metric



METRIC COARSE		INSTALLED LENGTH			METRIC FINE		PRICE EACH PER INSERT (100 PER BAG)				
Thread	Part No.	inches	mm	Dia		Part No.	POA	100+	500+	1000+	5000+
		0.315	8.0	1D	M8 x 0.75	08082	POA	0.787	0.561	0.449	0.334
		0.394	10.0	1.25D		08083	POA	0.890	0.637	0.509	0.386
		0.472	12.0	1.5D		08084	POA	1.014	0.725	0.579	0.438
		0.63	16.0	2D							
		0.787	20.0	2.5D							
M9 x 1.25	05092	0.354	9.0	1D				0.787	0.561	0.449	0.334
	05093	0.531	13.5	1.5D				0.890	0.637	0.509	0.386
	05094	0.709	18.0	2D				1.014	0.725	0.579	0.438
	05095	0.886	22.5	2.5D			POA	1.221	0.873	0.697	0.521
	05096	1.063	27.0	3D			POA	1.449	1.034	0.828	0.626
		0.354	9.0	1D	M9 x 1	07092		0.787	0.561	0.449	0.334
		0.531	13.5	1.5D		07093		0.890	0.637	0.509	0.386
		0.709	18.0	2D		07094	POA	1.014	0.725	0.579	0.438
		0.886	22.5	2.5D		07095	POA	1.221	0.873	0.697	0.521
		1.063	27.0	3D		07096	POA	1.449	1.034	0.828	0.626
		0.394	10.0	1D					0.787	0.561	0.449
M10 x 1.5	05102	0.394	10.0	1D				0.890	0.637	0.509	0.386
	05103	0.591	15.0	1.5D				1.014	0.725	0.579	0.438
	05104	0.787	20.0	2D				1.221	0.873	0.697	0.521
	05105	0.984	25.0	2.5D				1.449	1.034	0.828	0.626
	05106	1.181	30.0	3D				1.449	1.034	0.828	0.626
		0.394	10.0	1D	M10 x 1.25	07102		0.787	0.561	0.449	0.334
		0.591	15.0	1.5D		07103		0.890	0.637	0.509	0.386
		0.787	20.0	2D		07104		1.014	0.725	0.579	0.438
		0.984	25.0	2.5D		07105		1.221	0.873	0.697	0.521
		1.181	30.0	3D		07106		1.449	1.034	0.828	0.626
		0.394	10.0	1D	M10 x 1	08102		0.787	0.561	0.449	0.334
		0.591	15.0	1.5D		08103		0.890	0.637	0.509	0.386
		0.787	20.0	2D		08104		1.014	0.725	0.579	0.438
		0.984	25.0	2.5D		08105		1.221	0.873	0.697	0.521
		1.181	30.0	3D		08106		1.449	1.034	0.828	0.626
M11 x 1.5	05112	0.433	11.0	1D				1.149	0.821	0.657	0.490
	05113	0.650	16.5	1.5D				1.242	0.887	0.710	0.532
	05114	0.866	22.0	2D				1.449	1.034	0.828	0.626
	05115	1.083	27.5	2.5D				1.862	1.330	1.064	0.803
	05116	1.299	33.0	3D				2.069	1.478	1.182	0.886
		0.433	11.0	1D	M11 x 1.25	07112		1.149	0.821	0.657	0.490
		0.650	16.5	1.5D		07113		1.242	0.887	0.710	0.532
		0.866	22.0	2D		07114		1.449	1.034	0.828	0.626
		1.083	27.5	2.5D		07115	POA	1.862	1.330	1.064	0.803
		1.299	33.0	3D		07116	POA	2.069	1.478	1.182	0.886
		0.433	11.0	1D	M11 x 1	08112		1.149	0.821	0.657	0.490
		0.650	16.5	1.5D		08113		1.242	0.887	0.710	0.532
		0.866	22.0	2D		08114		1.449	1.034	0.828	0.626
		1.083	27.5	2.5D		08115	POA	1.862	1.330	1.064	0.803
		1.299	33.0	3D		08116	POA	2.069	1.478	1.182	0.886
M12 x 1.75	05122	0.472	12.0	1D				1.149	0.821	0.657	0.490
	05120-15	0.591	15.0	1.25D				1.242	0.887	0.710	0.532
	05123	0.709	18.0	1.5D				1.242	0.887	0.710	0.532
	05124	0.945	24.0	2D				1.449	1.034	0.828	0.626
	05125	1.181	30.0	2.5D				1.862	1.330	1.064	0.803
	05126	1.417	36.0	3D				2.069	1.478	1.182	0.886

Australian Price List Effective May 2013

Note! All prices are exclusive of GST

POA - Price On Application - denotes non-popular parts.

Minimum quantities and order values may apply.

Only supplied in full bag quantities.

Dry film lubing and plating available.

Bulk Inserts Free Running - Metric

Only Supplied in Full Bag quantities.



METRIC COARSE		INSTALLED LENGTH			METRIC FINE		PRICE EACH PER INSERT (100 PER BAG)				
Thread	Part No.	inches	mm	Dia		Part No.	POA	100+	500+	1000+	5000+
		0.472	12.0	1D	M12 x 1.5	07122		1.149	0.821	0.657	0.490
		0.709	18.0	1.5D		07123		1.242	0.887	0.710	0.532
		0.945	24.0	2D		07124		1.449	1.034	0.828	0.626
		1.181	30.0	2.5D		07125		1.862	1.330	1.064	0.803
		1.417	36.0	3D		07126		2.069	1.478	1.182	0.886
M12 x 1.25	08122	0.472	12	1D				1.149	0.821	0.657	0.490
	08123	0.709	18.0	1.5D				1.242	0.887	0.710	0.532
	08124	0.945	24.0	2D				1.449	1.034	0.828	0.626
	08125	1.181	30.0	2.5D			POA	1.862	1.330	1.064	0.803
	08126	1.417	36.0	3D			POA	2.069	1.478	1.182	0.886
M12 x 1	08122-1.0	0.472	12.0	1D			POA	1.608	1.149	0.918	0.688
	08123-1.0	0.709	18.0	1.5D				1.738	1.242	0.994	0.740
	08124-1.0	0.945	24.0	2D			POA	2.028	1.449	1.159	0.865
	08125-1.0	1.181	30.0	2.5D			POA	2.607	1.862	1.490	1.115
	08126-1.0	1.417	36.0	3D			POA	2.897	2.069	1.655	1.241

METRIC COARSE		INSTALLED LENGTH			METRIC FINE		PRICE EACH PER INSERT (50 PER BAG)				
Thread	Part No.	inches	mm	Dia		Part No.	POA	50+	250+	500+	1000+
M13 x 1.75		0.512	13.0	1D							
	05133	0.768	19.5	1.5D			POA	3.685	2.633	2.106	1.585
		1.024	26	2D							
		1.280	32.5	2.5D							
		1.535	39.0	3D							
		0.512	13.0	1D	M13 x 1.5						
		0.768	19.5	1.5D		07133	POA	3.685	2.633	2.106	1.585
		1.024	26	2D							
		1.280	32.5	2.5D							
		1.535	39.0	3D							
		0.768	19.5	1.5D	M13 x 1.25	08133	POA	3.685	2.633	2.106	1.585
M14 x 2	05142	0.551	14.0	1D				1.534	1.097	0.877	0.657
	05143	0.827	21.0	1.5D				1.966	1.404	1.124	0.844
	05144	1.102	28.0	2D				2.459	1.756	1.404	1.053
	05145	1.378	35.0	2.5D				3.047	2.178	1.742	1.303
	05146	1.654	42.0	3D				3.539	2.528	2.022	1.522
		0.551	14.0	1D	M14 x 1.5	07142		1.534	1.097	0.877	0.657
		0.827	21.0	1.5D		07143		1.966	1.404	1.124	0.844
		1.102	28.0	2D		07144		2.459	1.756	1.404	1.053
		1.378	35.0	2.5D		07145	POA	3.047	2.178	1.742	1.303
		1.654	42.0	3D		07146	POA	3.539	2.528	2.022	1.522
M15 x 2	05152	0.591	15.0	1D			POA	1.966	1.404	1.124	0.844
	05153	0.886	22.5	1.5D				2.421	1.730	1.383	1.043
	05154	1.181	30.0	2D			POA	3.105	2.216	1.773	1.334
	05155	1.476	37.5	2.5D			POA	3.725	2.660	2.129	1.595
	05156	1.772	45.0	3D			POA	4.345	3.105	2.483	1.866

Australian Price List Effective May 2013
 Note! All prices are exclusive of GST
 POA - Price On Application - denotes non-popular parts.
 Minimum quantities and order values may apply.

Only supplied in full bag quantities.
 Dry film lubing and plating available.

Bulk Inserts Free Running - Metric

Only Supplied in Full Bag quantities.



METRIC COARSE		INSTALLED LENGTH		Dia	METRIC FINE	PRICE EACH PER INSERT (50 PER BAG)					
Thread	Part No.	inches	mm			Part No.	POA	50+	250+	500+	1000+
		0.591	15.0	1D	M15 x 1.5	07152	POA	1.966	1.404	1.124	0.844
		0.886	22.5	1.5D		07153		2.421	1.730	1.383	1.043
		1.181	30.0	2D		07154	POA	3.105	2.216	1.773	1.334
		1.476	37.5	2.5D		07155	POA	3.725	2.660	2.129	1.595
		1.772	45.0	3D		07156	POA	4.345	3.105	2.483	1.866
M16 x 2	05162	0.63	16.0	1D				1.966	1.404	1.124	0.844
	05160-20	0.787	20.0	1.25D		POA	2.421	1.730	1.383	1.043	
	05163	0.945	24.0	1.5D			2.421	1.730	1.383	1.043	
	05164	1.26	32.0	2D			3.105	2.216	1.773	1.334	
	05165	1.575	40.0	2.5D			3.725	2.660	2.129	1.595	
	05166	1.89	48.0	3D			4.345	3.105	2.483	1.866	
		0.63	16.0	1D	M16 x 1.5	07162		1.966	1.404	1.124	0.844
		0.945	24.0	1.5D		07163		2.421	1.730	1.383	1.043
		1.26	32.0	2D		07164		3.105	2.216	1.773	1.334
		1.575	40.0	2.5D		07165	POA	3.725	2.660	2.129	1.595
		1.89	48.0	3D		07166	POA	4.345	3.105	2.483	1.866
M18 x 2.5	05182	0.709	18.0	1D			2.814	2.009	1.606	1.209	
	05183	1.063	27.0	1.5D			3.311	2.364	1.892	1.418	
	05184	1.417	36.0	2D			4.345	3.105	2.483	1.866	
	05185	1.772	45.0	2.5D			5.380	3.844	3.074	2.304	
	05186	2.126	54.0	3D			6.415	4.582	3.665	2.721	
			0.709	18.0	1D	M18 x 2	07182	POA	2.814	2.009	1.606
		1.063	27.0	1.5D	07183			3.311	2.364	1.892	1.418
		1.417	36.0	2D	07184		POA	4.345	3.105	2.483	1.866
		1.772	45.0	2.5D	07185		POA	5.380	3.844	3.074	2.304
		2.126	54.0	3D	07186		POA	6.415	4.582	3.665	2.721
		0.709	18.0	1D	M18 x 1.5	08182		2.814	2.009	1.606	1.209
		1.063	27.0	1.5D		08183		3.311	2.364	1.892	1.418
		1.417	36.0	2D		08184		4.345	3.105	2.483	1.866
		1.772	45.0	2.5D		08185		5.380	3.844	3.074	2.304
		2.126	54.0	3D		08186	POA	6.415	4.582	3.665	2.752

METRIC COARSE		INSTALLED LENGTH		Dia	METRIC FINE	PRICE EACH PER INSERT (50 PER BAG)					
Thread	Part No.	inches	mm			Part No.	POA	25+	125+	250+	500+
M20 x 2.5	05202	0.787	20.0	1D			3.931	2.807	2.247	1.689	
	05200-25	0.984	25.0	1.25D		POA	4.553	3.253	2.601	1.952	
	05203	1.181	30.0	1.5D			4.553	3.253	2.601	1.949	
	05204	1.575	40.0	2D			5.173	3.696	2.957	2.221	
	05205	1.969	50.0	2.5D			5.702	4.072	3.258	2.439	
	05206	2.362	60.0	3D			6.685	4.775	3.819	2.867	
		0.787	20.0	1D	M20 x 2	07202	POA	3.931	2.807	2.247	1.689
		1.181	30.0	1.5D		07203		4.553	3.253	2.601	1.949
		1.575	40.0	2D		07204		5.173	3.696	2.957	2.221
		1.969	50.0	2.5D		07205	POA	5.702	4.072	3.258	2.439
		2.362	60.0	3D		07206	POA	6.685	4.775	3.819	2.867
		0.787	20.0	1D	M20 x 1.5	08202		3.931	2.807	2.247	1.689
		1.181	30.0	1.5D		08203		4.553	3.253	2.601	1.949
		1.575	40.0	2D		08204		5.173	3.696	2.957	2.221
		1.969	50.0	2.5D		08205	POA	5.702	4.072	3.258	2.439
		2.362	60.0	3D		08206	POA	6.685	4.775	3.819	2.867

Australian Price List Effective May 2013

Note! All prices are exclusive of GST

POA - Price On Application - denotes non-popular parts.

Minimum quantities and order values may apply.

Only supplied in full bag quantities.

Dry film lubing and plating available.

Bulk Inserts Free Running - Metric

Only Supplied in Full Bag quantities.



METRIC COARSE		INSTALLED LENGTH		Dia	METRIC FINE		PRICE EACH PER INSERT (50 PER BAG)				
Thread	Part No.	inches	mm		Part No.	POA	25+	125+	250+	500+	
M22 x 2.5	05222	0.866	22.0	1D			4.966	3.548	2.838	2.127	
	05223	1.299	33.0	1.5D			5.691	4.066	3.253	2.439	
	05224	1.732	44.0	2D			6.622	4.730	3.783	2.836	
	05225	2.165	55.0	2.5D		POA	7.767	5.547	4.438	3.326	
	05226	2.598	66.0	3D		POA	9.043	6.459	5.168	3.878	
		0.866	22.0	1D	M22 x 2	07222	POA	4.966	3.548	2.838	2.127
		1.299	33.0	1.5D		07223		5.691	4.066	3.253	2.439
		1.732	44.0	2D		07224	POA	6.622	4.730	3.783	2.836
		2.165	55.0	2.5D		07225	POA	7.767	5.547	4.438	3.326
		2.598	66.0	3D		07226	POA	9.043	6.459	5.168	3.878
		0.866	22.0	1D	M22 x 1.5	08222		4.966	3.548	2.838	2.127
		1.299	33.0	1.5D		08223		5.691	4.066	3.253	2.439
		1.732	44.0	2D		08224		6.622	4.730	3.783	2.836
		2.165	55.0	2.5D		08225		7.767	5.547	4.438	3.326
		2.598	66.0	3D		08226	POA	9.043	6.459	5.168	3.878
M24 x 3	05242	0.945	24.0	1D			6.208	4.435	3.548	2.658	
	05243	1.417	36.0	1.5D			7.036	5.026	4.020	3.013	
	05244	1.89	48.0	2D			8.070	5.764	4.611	3.461	
	05245	2.362	60.0	2.5D			9.725	6.946	5.558	4.170	
	05246	2.835	72.0	3D			10.966	7.833	6.266	4.702	
		0.945	24.0	1D	M24 x 2	07242	POA	6.208	4.435	3.548	2.658
		1.417	36.0	1.5D		07243		7.036	5.026	4.020	3.013
		1.89	48.0	2D		07244	POA	8.070	5.764	4.611	3.461
		2.362	60.0	2.5D		07245	POA	9.725	6.946	5.558	4.170
		2.835	72.0	3D		07246	POA	10.966	7.833	6.266	4.702
		0.945	24.0	1D	M24 x 1.5	08242		6.208	4.435	3.548	2.658
		1.417	36.0	1.5D		08243		7.036	5.026	4.020	3.013
		1.89	48.0	2D		08244		8.070	5.764	4.611	3.461
		2.362	60.0	2.5D		08245	POA	9.725	6.946	5.558	4.170
		2.835	72.0	3D		08246	POA	10.966	7.833	6.266	4.702
		1.024	26.0	1D	M26 x 1.5	08262		9.043	6.459	5.168	3.878
		1.535	39.0	1.5D		08263		10.615	7.583	6.065	4.545
		2.047	52.0	2D		08264	POA	12.384	8.847	7.076	5.306
		2.559	65.0	2.5D		08265	POA	14.484	10.347	8.276	6.213
		3.071	78.0	3D		08266	POA	16.554	11.824	9.460	7.099

METRIC COARSE		INSTALLED LENGTH		Dia	METRIC FINE		PRICE EACH PER INSERT (50 PER BAG)				
Thread	Part No.	inches	mm		Part No.	POA	10+	50+	100+	500+	
M27 x 3	05272	1.063	27.0	1D		POA	9.043	6.459	5.168	3.878	
	05273	1.594	40.5	1.5D			10.615	7.583	6.065	4.545	
	05274	2.126	54.0	2D			12.384	8.847	7.076	5.306	
	05275	2.657	67.5	1.5D		POA	14.484	10.347	8.276	6.213	
	05276	3.189	81.0	3D		POA	16.554	11.824	9.460	7.099	
		1.063	27.0	1D	M27 x 2	07272		9.043	6.459	5.168	3.878
		1.594	40.5	1.5D		07273	POA	10.615	7.583	6.065	4.545
		2.126	54.0	2D		07274		12.384	8.847	7.076	5.306
		2.657	67.5	2.5D		07275	POA	14.484	10.347	8.276	6.213
		3.189	81.0	3D		07276	POA	16.554	11.824	9.460	7.099
		1.063	27.0	1D	M27 x 1.5	08272	POA	9.043	6.459	5.168	3.878
		1.594	40.5	1.5D		08273	POA	10.615	7.583	6.065	4.545
		2.126	54.0	2D		08274	POA	12.384	8.847	7.076	5.306
		2.657	67.5	2.5D		08275	POA	14.484	10.347	8.276	6.213
		3.189	81.0	3D		08276	POA	16.554	11.824	9.460	7.099

Australian Price List Effective May 2013

Note! All prices are exclusive of GST

POA - Price On Application - denotes non-popular parts.

Minimum quantities and order values may apply.

Only supplied in full bag quantities.

Dry film lubing and plating available.

Bulk Inserts Free Running - Metric

Only Supplied in Full Bag quantities.



METRIC COARSE		INSTALLED LENGTH		Dia	METRIC FINE		PRICE EACH PER INSERT (50 PER BAG)				
Thread	Part No.	inches	mm		Part No.	POA	10+	50+	100+	500+	
M30 x 3.5	05302	1.181	30.0	1D			9.830	7.021	5.617	4.212	
	05300-3.5	1.476	37.5	1.25D							
	05303	1.772	45.0	1.5D			11.794	8.424	6.740	5.056	
	05304	2.362	60.0	2D			13.957	9.969	7.975	5.984	
	05305	2.953	75.0	2.5D		POA	16.554	11.824	9.460	7.099	
	05306	3.543	90.0	3D		POA	18.623	13.302	10.642	7.986	
		1.181	30.0	1D	M30 x 2	07302	POA	9.830	7.021	5.617	4.212
		1.772	45.0	1.5D		07303		11.794	8.424	6.740	5.056
		2.362	60.0	2D		07304	POA	13.957	9.969	7.975	5.984
		2.953	75.0	2.5D		07305	POA	16.554	11.824	9.460	7.099
		3.543	90.0	3D		07306	POA	18.623	13.302	10.642	7.986
M30 x 3	05302-3	1.181	30.0	1D		POA	9.830	7.021	5.617	4.212	
	05303-3	1.772	45.0	1.5D			11.794	8.424	6.740	5.056	
	05304-3	2.362	60.0	2D		POA	13.957	9.969	7.975	5.984	
	05305-3	2.953	75.0	2.5D			16.554	11.824	9.460	7.099	
	05306-3	3.543	90.0	3D			18.623	13.302	10.642	7.986	
		1.181	30.0	1D	M30 x 1.5	08302		9.830	7.021	5.617	4.212
		1.772	45.0	1.5D		08303	POA	11.794	8.424	6.740	5.056
		2.362	60.0	2D		08304	POA	13.957	9.969	7.975	5.984
		2.953	75.0	2.5D		08305	POA	16.554	11.824	9.460	7.099
		3.543	90.0	3D		08306	POA	18.623	13.302	10.642	7.986
M33 x 3.5	05332	1.299	33.0	1D		POA	10.812	7.723	6.178	4.639	
	05333	1.949	49.5	1.5D			13.449	9.608	7.685	5.765	
	05334	2.598	66.0	2D		POA	16.554	11.824	9.460	7.099	
	05335	3.248	82.5	2.5D		POA	18.623	13.302	10.642	7.986	
	05336	3.898	99.0	3D		POA	22.762	16.259	13.006	9.758	
		1.299	33.0	1D	M33 x 2	07332	POA	10.812	7.723	6.178	4.639
		1.949	49.5	1.5D		07333	POA	13.449	9.608	7.685	5.765
		2.598	66.0	2D		07334	POA	16.554	11.824	9.460	7.099
		3.248	82.5	2.5D		07335	MIN	18.623	13.302	10.642	7.986
		3.898	99.0	3D		07336	MIN	22.762	16.259	13.006	9.758
M33 x 3	07332-3	1.299	33.00	1D							
	07333-3	1.949	49.50	1.5D							
	07334-3	2.598	66.00	2D							
	07335-3	3.248	82.50	2.5D							
	07336-3	3.898	99.00	3D							
M36 x 3	07362	1.417	36.0	1D			12.415	8.869	7.094	5.317	
	07363	2.126	54.0	1.5D			14.484	10.347	8.276	6.213	
	07364	2.835	72.0	2D			18.623	13.302	10.642	7.986	
	07365	3.543	90.0	2.5D		POA	22.762	16.259	13.006	9.758	
	07366	4.252	108.0	3D		POA	26.901	19.214	15.372	11.530	
		1.417	36.0	1D	M36 x 1.5	08362	POA	12.415	8.869	7.094	5.317
		2.126	54.0	1.5D		08363	POA	14.484	10.347	8.276	6.213
		2.835	72.0	2D		08364	POA	18.623	13.302	10.642	7.986
		3.543	90.0	2.5D		08365	POA	22.762	16.259	13.006	9.758
		4.252	108.0	3D		08366	POA	26.901	19.214	15.372	11.530

Australian Price List Effective May 2013

Note! All prices are exclusive of GST

POA - Price On Application - denotes non-popular parts.

Minimum quantities and order values may apply.

Only supplied in full bag quantities.

Dry film lubing and plating available.

Bulk Inserts Free Running - Metric

Only Supplied in Full Bag quantities.



METRIC COARSE		INSTALLED LENGTH		Dia	METRIC FINE		PRICE EACH PER INSERT (50 PER BAG)				
Thread	Part No.	inches	mm		Part No.	POA	10+	50+	100+	500+	
M36 x 4.0	05362	1.417	36.0	1D			12.415	8.869	7.094	5.317	
	05363	2.126	54.0	1.5D			14.484	10.347	8.276	6.213	
	05364	2.835	72.0	2D			18.623	13.302	10.642	7.986	
	05365	3.543	90.0	2.5D		POA	22.762	16.259	13.006	9.758	
	05366	4.252	108.0	3D		POA	26.901	19.214	15.372	11.530	
		1.417	36.0	1D	M36 x 2	07362-2					
		2.126	54.0	1.5D		07363-2					
		2.835	72.0	2D		07364-2					
		3.543	90.0	2.5D		07365-2					
		4.252	108.0	3D		07366-2					
M39 x 4	05392	1.535	39.0	1D			13.449	9.608	7.685	5.765	
	05393	2.303	58.5	1.5D			16.554	11.824	9.460	7.099	
	05394	3.071	78.0	2D			20.693	14.781	11.824	8.872	
	05395	3.839	97.5	2.5D		POA	26.901	19.214	15.372	11.530	
	05396	4.606	117.0	3D		POA	33.108	23.648	18.918	14.188	
		1.535	39.0	1D	M39 x 3	07392	POA	13.449	9.608	7.685	5.765
		2.303	58.5	1.5D		07393		16.554	11.824	9.460	7.099
		3.071	78.0	2D		07394	POA	20.693	14.781	11.824	8.872
		3.839	97.5	2.5D		07395	POA	26.901	19.214	15.372	11.530
		4.606	117.0	3D		07396	POA	33.108	23.648	18.918	14.188
		1.535	39.0	1D	M39 x 2	08392	POA	13.449	9.608	7.685	5.765
		2.303	58.5	1.5D		08393		16.554	11.824	9.460	7.099
		3.071	78.0	2D		08394	POA	20.693	14.781	11.824	8.872
		3.839	97.5	2.5D		08395	POA	26.901	19.214	15.372	11.530
		4.606	117.0	3D		08396	POA	33.108	23.648	18.918	14.188
M42 x 4.5	05422	1.654	42.0	1D			POA	20.693	14.781	11.824	8.872
	05423	2.480	63.0	1.5D			26.901	19.214	15.372	11.530	
	05424	3.307	84.0	2D		POA	33.108	23.648	18.918	14.188	
		1.654	42.0	1D	M42 x 3	07422	POA	20.693	14.781	11.824	8.872
		2.480	63.0	1.5D		07423	POA	26.901	19.214	15.372	11.530
		3.307	84.0	2D		07424	POA	33.108	23.648	18.918	14.188
M42 x 4	05422-4	1.654	42.0	1D			POA	20.693	14.781	11.824	8.872
	05423-4	2.480	63.0	1.5D			26.901	19.214	15.372	11.530	
	05424-4	3.307	84.0	2D			33.108	23.648	18.918	14.188	
		1.654	42.0	1D	M42 x 2	08422	POA	20.693	14.781	11.824	8.872
		2.480	63.0	1.5D		08423	POA	26.901	19.214	15.372	11.530
		3.307	84.0	2D		08424	POA	33.108	23.648	18.918	14.188
M45 x 3	07453	2.657	67.5	1.5D			33.417	23.870	19.097	14.324	
M48 x 3	07483	2.835	72.0	1.5D			39.316	28.083	22.466	16.847	
		2.835	72.0	1.5D	M48 x 5	05483		39.316	28.083	22.466	16.847
M48 x 4	05483-4	2.835	72.0	1.5D			POA	41.281	29.487	23.590	17.691
M52 x 5	05523	3.071	78.0	1.5D			POA	43.246	30.890	24.712	18.536
		3.071	78.0	1.5D	M52 x 3	07523	POA	43.246	30.890	24.712	18.536

Australian Price List Effective May 2013

Note! All prices are exclusive of GST

POA - Price On Application - denotes non-popular parts.

Minimum quantities and order values may apply.

Only supplied in full bag quantities.

Dry film lubing and plating available.

Bulk Inserts Free Running - Metric - Sparkplug and Lefthand Thread

Only Supplied in Full Bag quantities.

Spark	Part Plug No.	Installed Length			POA	10+	100+	500+	1000+
		inch	D's	mm					
M10 x 1	08108	0.339		8.6		0.804	0.561	0.449	0.365
	08109	0.500		12.7		0.909	0.637	0.509	0.407
M12 x 1.25	08122	0.500		12.7		1.149	0.821	0.657	0.490
	08123	0.750		19.1		1.242	0.887	0.710	0.532
M14 x 1.25	08148	0.375		9.5		0.686	0.480	0.385	0.313
	08141	0.472		12.0		0.877	0.613	0.491	0.396
	08147	0.438		11.1		0.877	0.613	0.491	0.396
	08149	0.500		12.7		1.046	0.732	0.586	0.469
	08140	0.750		19.1		1.373	0.961	0.769	0.615
	08140-8.4	0.331		8.4	POA	0.697	0.489	0.390	0.313
	08140-12.4	0.488		12.4	POA	1.078	0.755	0.604	0.480
	08140-16.4	0.646		16.4	POA	1.478	1.034	0.828	0.667
M18 x 1.5	08189	0.500		12.7		1.942	1.360	1.087	0.876
M18 x 1.5	08181XUP	0.500		12.5		3.512	2.459	1.966	1.574

Metric	Part No.	Installed Length			POA	10+	100+	500+	1000+
		inch	D's	mm					
M6 x 1	05063LH	0.354	1.5D	9.0	POA	1.182	0.826	0.662	0.500
M8 x 1.25	05083LH	0.472	1.5D	12.0	POA	1.331	0.932	0.744	0.553
M10 x 1.5	05103LH	0.591	1.5D	15.0	POA	1.858	1.301	1.041	0.782
M12 x 1.75	05123LH	0.709	1.5D	18.0	POA	2.534	1.773	1.419	1.063

Bicycle Threads	Part No.	Installed Length			POA	10+	100+	500+	1000+
		inch		mm					
M10 x 1 x 6.8	08100-6.8*	0.256		6.8	poa	0.828	0.591		

Australian Price List Effective May 2013

Note! All prices are exclusive of GST

POA - Price On Application - denotes non-popular parts.

Minimum quantities and order values may apply.

Only supplied in full bag quantities.

Dry film lubing and plating available.

Bulk Inserts Free Running - UNC/UNF

Only Supplied in Full Bag quantities.



UNC		INSTALLED LENGTH			UNF		PRICE EACH PER INSERT (100 PER BAG)				
Thread Size	Part No.	inches	D's	mm	Thread Size	Part No.	POA	100+	500+	1000+	5000+
#2 - 56	03522	0.086	1D	2.2				0.621	0.443	0.354	0.271
	03523	0.129	1.5D	3.3				0.673	0.481	0.385	0.292
	03524	0.172	2D	4.4				0.704	0.502	0.402	0.302
	03525	0.215	2.5D	5.5				0.744	0.533	0.425	0.323
	03526	0.258	3D	6.6				0.817	0.585	0.467	0.354
#3 - 48	03532	0.099	1D	2.5				1.034	0.739	0.591	0.448
	03533	0.149	1.5D	3.8				1.118	0.798	0.639	0.480
	03534	0.198	2D	5			POA	1.180	0.843	0.674	0.511
	03535	0.248	2.5D	6.3			POA	1.242	0.887	0.710	0.532
	03536	0.297	3D	7.5			POA	1.366	0.976	0.780	0.584
#3 - 56		0.099	1D	2.5	#3 - 56	04532	POA	1.034	0.739	0.591	0.448
		0.149	1.5D	3.8		04533		1.118	0.798	0.639	0.480
		0.198	2D	5		04534	POA	1.180	0.843	0.674	0.511
		0.248	2.5D	6.3		04535	POA	1.242	0.887	0.710	0.532
		0.297	3D	7.5		04536	POA	1.366	0.976	0.780	0.584
#4 - 40	03542	0.112	1D	2.8				0.476	0.340	0.272	0.209
	03543	0.168	1.5D	4.3				0.508	0.363	0.290	0.219
	03544	0.224	2D	5.7				0.538	0.385	0.308	0.229
	03545	0.280	2.5D	7.1				0.579	0.415	0.332	0.250
	03546	0.336	3D	8.5				0.621	0.443	0.354	0.271
#4 - 48		0.112	1D	2.8	#4 - 48	04542	POA	0.476	0.340	0.272	0.209
		0.168	1.5D	4.3		04543		0.508	0.363	0.290	0.219
		0.224	2D	5.7		04544		0.538	0.385	0.308	0.229
		0.280	2.5D	7.1		04545	POA	0.579	0.415	0.332	0.250
		0.336	3D	8.5		04546		0.621	0.443	0.354	0.271
#5 - 40	03552	0.112	1D	2.8				0.476	0.340	0.272	0.209
	03553	0.168	1.5D	4.3				0.508	0.363	0.290	0.219
	03554	0.224	2D	5.7				0.538	0.385	0.308	0.229
	03555	0.280	2.5D	7.1			POA	0.579	0.415	0.332	0.250
	03556	0.336	3D	8.5			POA	0.621	0.443	0.354	0.271
#6 - 32	03562	0.138	1D	3.5				0.476	0.340	0.272	0.209
	03563	0.207	1.5D	5.3				0.508	0.363	0.290	0.219
	03564	0.276	2D	7				0.538	0.385	0.308	0.229
	03565	0.345	2.5D	8.8				0.579	0.415	0.332	0.250
	03566	0.414	3D	10.5				0.621	0.443	0.354	0.271
#6 - 40		0.138	1D	3.5	#6 - 40	04562	POA	0.476	0.340	0.272	0.209
		0.207	1.5D	5.3		04563		0.508	0.363	0.290	0.219
		0.276	2D	7		04564	POA	0.538	0.385	0.308	0.229
		0.345	2.5D	8.8		04565	POA	0.579	0.415	0.332	0.250
		0.414	3D	10.5		04566	POA	0.621	0.443	0.354	0.271
#8 - 32	03582	0.164	1D	4.2				0.476	0.340	0.272	0.209
	03583	0.246	1.5D	6.2				0.508	0.363	0.290	0.219
	03584	0.328	2D	8.3				0.538	0.385	0.308	0.229
	03585	0.410	2.5D	10.4				0.579	0.415	0.332	0.250
	03586	0.492	3D	12.5				0.621	0.443	0.354	0.271
#8 - 36		0.164	1D	4.2	#8 - 36	04582	POA	0.476	0.340	0.272	0.209
		0.246	1.5D	6.2		04583		0.508	0.363	0.290	0.219
		0.328	2D	8.3		04584	POA	0.538	0.385	0.308	0.229
		0.410	2.5D	10.4		04585	POA	0.579	0.415	0.332	0.250
		0.492	3D	12.5		04586	POA	0.621	0.443	0.354	0.271
#10 - 24	03602	0.190	1D	4.8				0.476	0.340	0.272	0.209
	03603	0.285	1.5D	7.2				0.508	0.363	0.290	0.219
	03604	0.380	2D	9.7				0.538	0.385	0.308	0.229
	03605	0.475	2.5D	12.1				0.579	0.415	0.332	0.250
	03606	0.570	3D	14.5				0.621	0.443	0.354	0.271
#10 - 32		0.190	1D	4.8	#10 - 32	04602		0.476	0.340	0.272	0.209
		0.285	1.5D	7.2		04603		0.508	0.363	0.290	0.219
		0.380	2D	9.7		04604		0.538	0.385	0.308	0.229
		0.475	2.5D	12.1		04605		0.579	0.415	0.332	0.250
		0.570	3D	14.5		04606		0.621	0.443	0.354	0.271

Australian Price List Effective May 2013

Note! All prices are exclusive of GST

POA - Price On Application - denotes non-popular parts.

Minimum quantities and order values may apply.

Only supplied in full bag quantities.

Dry film lubing and plating available.

Bulk Inserts Free Running - UNC/UNF

Only Supplied in Full Bag quantities.



UNC		INSTALLED LENGTH			UNF		PRICE EACH PER INSERT (100 PER BAG)				
Thread Size	Part No.	inches	D's	mm	Thread Size	Part No.	POA	100+	500+	1000+	5000+
#12 - 24	03622	0.216	1D	5.5			POA	0.548	0.392	0.314	0.240
	03623	0.324	1.5D	8.2				0.570	0.407	0.325	0.240
	03624	0.432	2D	11				0.642	0.459	0.367	0.271
	03625	0.540	2.5D	13.7			POA	0.683	0.489	0.390	0.292
	03626	0.648	3D	16.5			POA	0.744	0.533	0.425	0.323
		0.216	1D	5.5	#12 - 28	04622	POA	0.548	0.392	0.314	0.240
		0.324	1.5D	8.2		04623		0.570	0.407	0.325	0.240
		0.432	2D	11		04624		0.642	0.459	0.367	0.271
		0.540	2.5D	13.7		04625	POA	0.683	0.489	0.390	0.292
		0.648	3D	16.5		04626	POA	0.744	0.533	0.425	0.323
1/4 - 20	03042	0.250	1D	6.4				0.548	0.392	0.314	0.240
	03043	0.375	1.5D	9.5				0.570	0.407	0.325	0.240
	03044	0.500	2D	12.7				0.642	0.459	0.367	0.271
	03045	0.625	2.5D	15.9				0.683	0.489	0.390	0.292
	03046	0.750	3D	19.1				0.744	0.533	0.425	0.323
		0.250	1D	6.4	1/4 - 28	04042		0.548	0.392	0.314	0.240
		0.375	1.5D	9.5		04043		0.570	0.407	0.325	0.240
		0.500	2D	12.7		04044		0.642	0.459	0.367	0.271
		0.625	2.5D	15.9		04045		0.683	0.489	0.390	0.292
		0.750	3D	19.1		04046		0.744	0.533	0.425	0.323
5/16 - 18	03052	0.313	1D	8				0.602	0.428	0.343	0.261
	03053	0.470	1.5D	11.9				0.631	0.452	0.361	0.271
	03054	0.626	2D	15.9				0.694	0.495	0.395	0.302
	03055	0.783	2.5D	19.9				0.787	0.561	0.449	0.334
	03056	0.939	3D	23.9				0.890	0.637	0.509	0.386
		0.313	1D	8	5/16 - 24	04052		0.602	0.428	0.343	0.261
		0.470	1.5D	11.9		04053		0.631	0.452	0.361	0.271
		0.626	2D	15.9		04054		0.694	0.495	0.395	0.302
		0.783	2.5D	19.9		04055		0.787	0.561	0.449	0.334
		0.939	3D	23.9		04056		0.890	0.637	0.509	0.386
3/8 - 16	03062	0.375	1D	9.5				0.808	0.577	0.461	0.344
	03063	0.563	1.5D	14.3				0.890	0.637	0.509	0.386
	03064	0.750	2D	19.1				1.034	0.739	0.591	0.448
	03065	0.938	2.5D	23.8				1.180	0.843	0.674	0.511
	03066	1.125	3D	28.6				1.346	0.961	0.769	0.573
		0.375	1D	9.5	3/8 - 24	04062		0.808	0.577	0.461	0.344
		0.563	1.5D	14.3		04063		0.890	0.637	0.509	0.386
		0.750	2D	19.1		04064		1.034	0.739	0.591	0.448
		0.938	2.5D	23.8		04065		1.180	0.843	0.674	0.511
		1.125	3D	28.6		04066		1.346	0.961	0.769	0.573
7/16 - 14	03072	0.438	1D	11.1				0.994	0.710	0.568	0.427
	03073	0.657	1.5D	16.7				1.056	0.755	0.604	0.459
	03074	0.876	2D	22.3				1.180	0.843	0.674	0.511
	03075	1.095	2.5D	27.8				1.449	1.034	0.828	0.626
	03076	1.314	3D	33.4				1.655	1.182	0.946	0.709
		0.438	1D	11.1	7/16 - 20	04072		0.994	0.710	0.568	0.427
		0.657	1.5D	16.7		04073		1.056	0.755	0.604	0.459
		0.876	2D	22.3		04074		1.180	0.843	0.674	0.511
		1.095	2.5D	27.8		04075		1.449	1.034	0.828	0.626
		1.314	3D	33.4		04076	POA	1.655	1.182	0.946	0.709
1/2 - 13	03082	0.500	1D	12.7				1.138	0.813	0.651	0.490
	03083	0.750	1.5D	19.1				1.211	0.865	0.692	0.521
	03084	1.000	2D	25.4				1.366	0.976	0.780	0.584
	03085	1.250	2.5D	31.8				1.655	1.182	0.946	0.709
	03086	1.500	3D	38.1				1.966	1.404	1.124	0.844
		0.500	1D	12.7	1/2 - 20	04082		1.138	0.813	0.651	0.490
		0.750	1.5D	19.1		04083		1.211	0.865	0.692	0.521
		1.000	2D	25.4		04084		1.366	0.976	0.780	0.584
		1.250	2.5D	31.8		04085		1.655	1.182	0.946	0.709
		1.500	3D	38.1		04086		1.966	1.404	1.124	0.844

Australian Price List Effective May 2013

Note! All prices are exclusive of GST

POA - Price On Application - denotes non-popular parts.

Minimum quantities and order values may apply.

Only supplied in full bag quantities.

Dry film lubing and plating available.

Bulk Inserts Free Running - UNC/UNF

Only Supplied in Full Bag quantities.



UNC Thread Size	Part No.	INSTALLED LENGTH			UNF Thread Siz.5e	Part No.	PRICE EACH PER INSERT (100 PER BAG)				
		inches	D's	mm			POA	50+	100+	500+	1000+
9/16 - 12	03092	0.563	1D	14.3				1.449	1.034	0.828	0.626
	03093	0.845	1.5D	21.5				1.655	1.182	0.946	0.709
	03094	1.126	2D	28.6				2.380	1.700	1.360	1.022
	03095	1.408	2.5D	35.8				3.001	2.143	1.715	1.282
	03096	1.689	3D	42.9			POA	3.622	2.586	2.069	1.553
		0.563	1D	14.3	9/16 - 18	04092		1.449	1.034	0.828	0.626
		0.845	1.5D	21.5		04093		1.655	1.182	0.946	0.709
		1.126	2D	28.6		04094		2.380	1.700	1.360	1.022
		1.408	2.5D	35.8		04095	POA	3.001	2.143	1.715	1.282
		1.689	3D	42.9		04096	POA	3.622	2.586	2.069	1.553
5/8 - 11	03102	0.625	1D	15.9				1.945	1.389	1.111	0.834
	03103	0.938	1.5D	23.8				2.380	1.700	1.360	1.022
	03104	1.250	2D	31.8				3.021	2.158	1.726	1.293
	03105	1.563	2.5D	39.7				3.642	2.601	2.081	1.564
	03106	1.875	3D	47.6				4.345	3.105	2.483	1.866
		0.625	1D	15.9	5/8 - 18	04102		1.945	1.389	1.111	0.834
		0.938	1.5D	23.8		04103		2.380	1.700	1.360	1.022
		1.250	2D	31.8		04104		3.021	2.158	1.726	1.293
		1.563	2.5D	39.7		04105	POA	3.642	2.601	2.081	1.564
		1.875	3D	47.6		04106	POA	4.345	3.105	2.483	1.866
11/16 - 11	03112	0.688	1D	17.5			POA	2.556	1.825	1.460	1.095
	03113	1.032	1.5D	26.2				3.145	2.247	1.797	1.345
	03114	1.376	2D	35			POA	3.931	2.807	2.247	1.689
	03115	1.720	2.5D	43.7				4.717	3.370	2.696	2.022
	03116	2.064	3D	52.4				5.897	4.213	3.370	2.533
3/4 - 10	03122	0.750	1D	19.1				2.794	1.995	1.597	1.199
	03123	1.125	1.5D	28.6				3.301	2.358	1.886	1.418
	03124	1.500	2D	38.1				4.345	3.105	2.483	1.866
	03125	1.875	2.5D	47.6				5.298	3.783	3.026	2.273
	03126	2.250	3D	57.2				6.208	4.435	3.548	2.658
		0.750	1D	19.1	3/4 - 16	04122		2.794	1.995	1.597	1.199
		1.125	1.5D	28.6		04123		3.301	2.358	1.886	1.418
		1.500	2D	38.1		04124		4.345	3.105	2.483	1.866
		1.875	2.5D	47.6		04125		5.298	3.783	3.026	2.273
		2.250	3D	57.2		04126	POA	6.208	4.435	3.548	2.658

UNC Thread Size	Part No.	INSTALLED LENGTH			UNF Thread Size	Part No.	PRICE EACH PER INSERT (100 PER BAG)				
		inches	D's	mm			POA	25+	50+	100+	500+
7/8 - 9	03142	0.875	1D	22.2				4.759	3.400	2.720	2.043
	03143	1.313	1.5D	33.3				5.587	3.991	3.192	2.398
	03144	1.750	2D	44.5				6.415	4.582	3.665	2.752
	03145	2.188	2.5D	55.6			POA	7.242	5.173	4.139	3.107
	03146	2.625	3D	66.7				8.276	5.912	4.730	3.545
		0.875	1D	22.2	7/8 - 14	04142		4.759	3.400	2.720	2.043
		1.313	1.5D	33.3		04143		5.587	3.991	3.192	2.398
		1.750	2D	44.5		04144	POA	6.415	4.582	3.665	2.752
		2.188	2.5D	55.6		04145	POA	7.242	5.173	4.139	3.107
		2.625	3D	66.7		04146	POA	8.276	5.912	4.730	3.545
1" - 8	03162	1.000	1D	25.4				6.104	4.361	3.488	2.617
	03163	1.500	1.5D	38.1				7.036	5.026	4.020	3.013
	03164	2.000	2D	50.8				8.070	5.764	4.611	3.461
	03165	2.500	2.5D	63.5			POA	9.519	6.799	5.439	4.076
	03166	3.000	3D	76.2			POA	10.760	7.685	6.149	4.608
		1.000	1D	25.4	1" - 12	04162		6.104	4.361	3.488	2.617
		1.500	1.5D	38.1		04163		7.036	5.026	4.020	3.013
		2.000	2D	50.8		04164	POA	8.070	5.764	4.611	3.461
		2.500	2.5D	63.5		04165	POA	9.519	6.799	5.439	4.076
		3.000	3D	76.2		04166	POA	10.760	7.685	6.149	4.608

Australian Price List Effective May 2013

Note! All prices are exclusive of GST

POA - Price On Application - denotes non-popular parts.

Minimum quantities and order values may apply.

Only supplied in full bag quantities.

Dry film lubing and plating available.

Bulk Inserts Free Running - UNC/UNF

Only Supplied in Full Bag quantities.



UNC		INSTALLED LENGTH			UNF		PRICE EACH PER INSERT (100 PER BAG)				
Thread Size	Part No.	inches	D's	mm	Thread Size	Part No.	POA	25+	50+	100+	500+
		1.000	1D	25.4	1"- 14	04162-14		6.104	4.361	3.488	2.617
		1.500	1.5D	38.1		04163-14		7.036	5.026	4.020	3.013
		2.000	2D	50.8		04164-14		8.070	5.764	4.611	3.461
		2.500	2.5D	63.5		04165-14	POA	9.519	6.799	5.439	4.076
		3.000	3D	76.2		04166-14	POA	10.760	7.685	6.149	4.608

UNC		INSTALLED LENGTH			UNF		PRICE EACH PER INSERT (100 PER BAG)				
Thread Size	Part No.	inches	D's	mm	Thread Size	Part No.	POA	10+	50+	100+	500+
1 1/8 - 7	03182	1.125	1D	28.6	1 1/8 - 12			9.830	7.021	5.617	4.212
	03183	1.688	1.5D	42.9		04182		9.830	7.021	5.617	4.212
	03184	2.250	2D	57.2		04183		10.347	7.390	5.912	4.431
	03185	2.813	2.5D	71.4		04184	POA	13.761	9.830	7.864	5.901
	03186	3.375	3D	85.7		04185	POA	15.726	11.233	8.986	6.745
		1.125	1D	28.6		04186	POA	17.692	12.637	10.110	7.579
		1.688	1.5D	42.9				9.830	7.021	5.617	4.212
		2.250	2D	57.2				10.347	7.390	5.912	4.431
		2.813	2.5D	71.4				13.761	9.830	7.864	5.901
		3.375	3D	85.7				15.726	11.233	8.986	6.745
1 1/4 - 7	03202	1.250	1D	31.8	1 1/4 - 12			10.812	7.723	6.178	4.639
	03203	1.875	1.5D	47.6		04202		10.812	7.723	6.178	4.639
	03204	2.500	2D	63.5		04203		11.794	8.424	6.740	5.056
	03205	3.125	2.5D	79.4		04204	POA	14.744	10.531	8.424	6.318
	03206	3.750	3D	95.3		04205	POA	17.692	12.637	10.110	7.579
		1.250	1D	31.8		04206	POA	19.657	14.040	11.233	8.423
		1.875	1.5D	47.6				10.812	7.723	6.178	4.639
		2.500	2D	63.5				11.794	8.424	6.740	5.056
		3.125	2.5D	79.4				14.744	10.531	8.424	6.318
		3.750	3D	95.3				17.692	12.637	10.110	7.579
1 3/8 - 6	03222	1.375	1D	34.9	1 3/8 - 12			11.794	8.424	6.740	5.056
	03223	2.063	1.5D	52.4		04222	POA	11.794	8.424	6.740	5.056
	03224	2.750	2D	69.9		04223	POA	12.415	8.869	7.094	5.317
	03225	3.438	2.5D	87.3		04224		17.692	12.637	10.110	7.579
	03226	4.125	3D	104.8		04225	POA	21.624	15.446	12.357	9.268
		1.375	1D	34.9		04226	POA	23.590	16.850	13.480	10.112
		2.063	1.5D	52.4				11.794	8.424	6.740	5.056
		2.750	2D	69.9				12.415	8.869	7.094	5.317
		3.438	2.5D	87.3				17.692	12.637	10.110	7.579
		4.125	3D	104.8				21.624	15.446	12.357	9.268
1 1/2 - 6	03242	1.500	1D	38.1	1 1/2 - 12			13.761	9.830	7.864	5.901
	03243	2.250	1.5D	57.2		04242		13.761	9.830	7.864	5.901
	03244	3.000	2D	76.2		04243		16.554	11.824	9.460	7.099
	03245	3.750	2.5D	95.3		04244	POA	21.624	15.446	12.357	9.268
	03246	4.500	3D	114.3		04245	POA	27.520	19.657	15.726	11.791
		1.500	1D	38.1		04246	POA	31.452	22.466	17.973	13.480
		2.250	1.5D	57.2				13.761	9.830	7.864	5.901
		3.000	2D	76.2				16.554	11.824	9.460	7.099
		3.750	2.5D	95.3				21.624	15.446	12.357	9.268
		4.500	3D	114.3				27.520	19.657	15.726	11.791

Australian Price List Effective May 2013

Note! All prices are exclusive of GST

POA - Price On Application - denotes non-popular parts.

Minimum quantities and order values may apply.

Only supplied in full bag quantities.

Dry film lubing and plating available.

Bulk Inserts Free Running - BSW/BSF

Only Supplied in Full Bag quantities.



BSW Thread Size	Part No.	INSTALLED LENGTH			BSF Thread Size	Part No.	PRICE EACH PER INSERT (100 PER BAG)				
		inches	D's	mm			POA	100+	500+	1000+	5000+
1/8 - 40	02022	0.125	1D	3.2				0.559	0.400	0.319	0.240
	02023	0.188	1.5D	4.8				0.579	0.415	0.332	0.250
	02024	0.250	2D	6.4				0.621	0.443	0.354	0.271
	02025	0.313	2.5D	7.9				0.744	0.533	0.425	0.323
	02026	0.375	3D	9.5				0.828	0.591	0.473	0.354
3/16 - 24	02032	0.188	1D	4.8				0.483	0.345	0.275	0.209
	02033	0.281	1.5D	7.1				0.512	0.366	0.292	0.219
	02034	0.376	2D	9.6				0.540	0.387	0.309	0.229
	02035	0.470	2.5D	11.9				0.621	0.443	0.354	0.271
	02036	0.564	3D	14.3				0.704	0.502	0.402	0.302
		0.188	1D	4.8	3/16 - 32	00032		0.483	0.345	0.275	0.209
		0.281	1.5D	7.1		00033		0.512	0.366	0.292	0.219
		0.376	2D	9.6		00034	POA	0.540	0.387	0.309	0.229
		0.470	2.5D	11.9		00035	POA	0.621	0.443	0.354	0.271
		0.564	3D	14.3		00036	POA	0.704	0.502	0.402	0.302
1/4 - 20	02042	0.250	1D	6.4				0.548	0.392	0.314	0.240
	02043	0.375	1.5D	9.5				0.570	0.407	0.325	0.240
	02044	0.500	2D	12.7				0.642	0.459	0.367	0.271
	02045	0.625	2.5D	15.9				0.673	0.481	0.385	0.292
	02046	0.750	3D	19.1				0.766	0.547	0.438	0.334
		0.250	1D	6.4	1/4 - 26	00042	POA	0.548	0.392	0.314	0.240
		0.375	1.5D	9.5		00043		0.570	0.407	0.325	0.240
		0.500	2D	12.7		00044		0.642	0.459	0.367	0.271
		0.625	2.5D	15.9		00045	POA	0.673	0.481	0.385	0.292
		0.750	3D	19.1		00046	POA	0.766	0.547	0.438	0.334
5/16 - 18	02052	0.313	1D	8				0.559	0.400	0.319	0.240
	02053	0.470	1.5D	11.9				0.642	0.459	0.367	0.271
	02054	0.626	2D	15.9				0.766	0.547	0.438	0.334
	02055	0.783	2.5D	19.9				0.932	0.665	0.533	0.396
	02056	0.939	3D	23.9				1.034	0.739	0.591	0.448
		0.313	1D	8	5/16 - 22	00052		0.559	0.400	0.319	0.240
		0.470	1.5D	11.9		00053		0.642	0.459	0.367	0.271
		0.626	2D	15.9		00054		0.766	0.547	0.438	0.334
		0.783	2.5D	19.9		00055	POA	0.932	0.665	0.533	0.396
		0.939	3D	23.9		00056	POA	1.034	0.739	0.591	0.448
3/8 - 16	02062	0.375	1D	9.5				0.787	0.561	0.449	0.334
	02063	0.563	1.5D	14.3				0.890	0.637	0.509	0.386
	02064	0.750	2D	19.1				1.014	0.725	0.579	0.438
	02065	0.938	2.5D	23.8				1.242	0.887	0.710	0.532
	02066	1.125	3D	28.6				1.449	1.034	0.828	0.626
		0.375	1D	9.5	3/8 - 20	00062		0.787	0.561	0.449	0.334
		0.563	1.5D	14.3		00063		0.890	0.637	0.509	0.386
		0.750	2D	19.1		00064		1.014	0.725	0.579	0.438
		0.938	2.5D	23.8		00065	POA	1.242	0.887	0.710	0.532
		1.125	3D	28.6		00066	POA	1.449	1.034	0.828	0.626
7/16 - 14	02072	0.438	1D	11.1				0.974	0.695	0.556	0.417
	02073	0.657	1.5D	16.7				1.056	0.755	0.604	0.459
	02074	0.876	2D	22.3				1.159	0.828	0.662	0.500
	02075	1.095	2.5D	27.8				1.346	0.961	0.769	0.573
	02076	1.314	3D	33.4				1.655	1.182	0.946	0.709
		0.438	1D	11.1	7/16 - 18	00072	POA	0.974	0.695	0.556	0.417
		0.657	1.5D	16.7		00073		1.056	0.755	0.604	0.459
		0.876	2D	22.3		00074	POA	1.159	0.828	0.662	0.500
		1.095	2.5D	27.8		00075	POA	1.346	0.961	0.769	0.573
		1.314	3D	33.4		00076	POA	1.655	1.182	0.946	0.709
1/2 - 12	02082	0.500	1D	12.7				1.149	0.821	0.657	0.490
	02083	0.750	1.5D	19.1				1.221	0.873	0.697	0.521
	02084	1.000	2D	25.4				1.449	1.034	0.828	0.626
	02085	1.250	2.5D	31.8				1.655	1.182	0.946	0.709
	02086	1.500	3D	38.1				2.277	1.625	1.301	0.980

Australian Price List Effective May 2013
Note! All prices are exclusive of GST

POA - Price On Application - denotes non-popular parts.

Minimum quantities and order values may apply.

Only supplied in full bag quantities. Dry film lubing and plating available.

Bulk Inserts Free Running - BSW/BSF

Only Supplied in Full Bag quantities.



BSW		INSTALLED LENGTH			BSF		PRICE EACH PER INSERT (100 PER BAG)				
Thread Size	Part No.	inches	D's	mm	Thread Size	Part No.	POA	100+	500+	1000+	5000+
		0.500	1D	12.7	1/2 - 16	00082		1.149	0.821	0.657	0.490
		0.750	1.5D	19.1		00083		1.221	0.873	0.697	0.521
		1.000	2D	25.4		00084		1.449	1.034	0.828	0.626
		1.250	2.5D	31.8		00085	POA	1.655	1.182	0.946	0.709
		1.500	3D	38.1		00086	POA	2.277	1.625	1.301	0.980

BSW		INSTALLED LENGTH			BSF		PRICE EACH PER INSERT (100 PER BAG)				
Thread Size	Part No.	inches	D's	mm	Thread Size	Part No.	POA	50+	100+	500+	1000+
9/16 - 12	02092	0.563	1D	14.3	9/16 - 16			1.449	1.034	0.828	0.626
	02093	0.845	1.5D	21.5				1.655	1.182	0.946	0.709
	02094	1.126	2D	28.6				2.380	1.700	1.360	1.022
	02095	1.408	2.5D	35.8				3.105	2.216	1.773	1.334
	02096	1.689	3D	42.9				3.725	2.660	2.129	1.595
		0.563	1D	14.3		00092	POA	1.449	1.034	0.828	0.626
		0.845	1.5D	21.5		00093		1.655	1.182	0.946	0.709
		1.126	2D	28.6		00094	POA	2.380	1.700	1.360	1.022
		1.408	2.5D	35.8		00095	MIN	3.105	2.216	1.773	1.334
		1.689	3D	42.9		00096	POA	3.725	2.660	2.129	1.595
5/8 - 11	02102	0.625	1D	15.9	5/8 - 14			1.945	1.389	1.111	0.834
	02103	0.938	1.5D	23.8				2.483	1.773	1.419	1.063
	02104	1.250	2D	31.8				3.105	2.216	1.773	1.334
	02105	1.563	2.5D	39.7				3.931	2.807	2.247	1.689
	02106	1.875	3D	47.6				4.759	3.400	2.720	2.043
		0.625	1D	15.9		00102		1.945	1.389	1.111	0.834
		0.938	1.5D	23.8		00103		2.483	1.773	1.419	1.063
		1.250	2D	31.8		00104		3.105	2.216	1.773	1.334
		1.563	2.5D	39.7		00105	POA	3.931	2.807	2.247	1.689
		1.875	3D	47.6		00106	POA	4.759	3.400	2.720	2.043
3/4 - 10	02122	0.750	1D	19.1	3/4 - 12			2.794	1.995	1.597	1.199
	02123	1.125	1.5D	28.6				3.311	2.364	1.892	1.418
	02124	1.500	2D	38.1				4.345	3.105	2.483	1.866
	02125	1.875	2.5D	47.6				5.587	3.991	3.192	2.398
	02126	2.250	3D	57.2				6.622	4.730	3.783	2.836
		0.750	1D	19.1		00122		2.794	1.995	1.597	1.199
		1.125	1.5D	28.6		00123		3.311	2.364	1.892	1.418
		1.500	2D	38.1		00124	POA	4.345	3.105	2.483	1.866
		1.875	2.5D	47.6		00125	POA	5.587	3.991	3.192	2.398
		2.250	3D	57.2		00126	POA	6.622	4.730	3.783	2.836

BSW		INSTALLED LENGTH			BSF		PRICE EACH PER INSERT (100 PER BAG)				
Thread Size	Part No.	inches	D's	mm	Thread Size	Part No.	POA	25+	50+	100+	500+
7/8 - 9	02142	0.875	1D	22.2	7/8 - 11			4.759	3.400	2.720	2.043
	02143	1.313	1.5D	33.3				5.587	3.991	3.192	2.398
	02144	1.750	2D	44.5				6.415	4.582	3.665	2.752
	02145	2.188	2.5D	55.6				7.656	5.469	4.375	3.284
	02146	2.625	3D	66.7				8.691	6.208	4.966	3.722
		0.875	1D	22.2		00142	POA	4.759	3.400	2.720	2.043
		1.313	1.5D	33.3		00143	POA	5.587	3.991	3.192	2.398
		1.750	2D	44.5		00144	POA	6.415	4.582	3.665	2.752
		2.188	2.5D	55.6		00145	POA	7.656	5.469	4.375	3.284
		2.625	3D	66.7		00146	POA	8.691	6.208	4.966	3.722
1" - 8	02162	1.000	1D	25.4	1" - 10			6.208	4.435	3.548	2.658
	02163	1.500	1.5D	38.1				7.036	5.026	4.020	3.013
	02164	2.000	2D	50.8				8.070	5.764	4.611	3.461
	02165	2.500	2.5D	63.5				9.932	7.094	5.675	4.253
	02166	3.000	3D	76.2				11.381	8.128	6.503	4.879
		1.000	1D	25.4		00162	POA	6.208	4.435	3.548	2.658
		1.500	1.5D	38.1		00163	POA	7.036	5.026	4.020	3.013
		2.000	2D	50.8		00164	POA	8.070	5.764	4.611	3.461
		2.500	2.5D	63.5		00165	POA	9.932	7.094	5.675	4.253
		3.000	3D	76.2		00166	POA	11.381	8.128	6.503	4.879

Australian Price List Effective May 2013
Note! All prices are exclusive of GST

POA - Price On Application - denotes non-popular parts.

Minimum quantities and order values may apply.

Only supplied in full bag quantities. Dry film lubing and plating available.

Bulk Inserts Free Running - BA/BSC/BSP

Only Supplied in Full Bag quantities.



BA		INSTALLED LENGTH				PRICE EACH PER INSERT (100 PER BAG)				
Thread Size	Part No.	inches	D's	mm	POA	100+	500+	1000+	5000+	
0BA	00502	0.236	1D	6		POA	0.828	0.591	0.473	0.354
	00503	0.354	1.5D	9			0.910	0.651	0.520	0.386
	00504	0.472	2D	12			1.076	0.769	0.614	0.459
	00505	0.591	2.5D	15		POA	1.324	0.946	0.757	0.573
	00506	0.709	3D	18		MIN	1.490	1.064	0.851	0.636
2BA	00522	0.185	1D	4.7			0.828	0.591	0.473	0.354
	00523	0.278	1.5D	7.1			0.910	0.651	0.520	0.386
	00524	0.370	2D	9.4		POA	1.076	0.769	0.614	0.459
	00525	0.463	2.5D	11.8		POA	1.324	0.946	0.757	0.573
	00526	0.555	3D	14.1		POA	1.490	1.064	0.851	0.636
4BA	00542	0.142	1D	3.6		POA	0.828	0.591	0.473	0.354
	00543	0.213	1.5D	5.4			0.910	0.651	0.520	0.386
	00544	0.283	2D	7.2		POA	1.076	0.769	0.614	0.459
	00545	0.354	2.5D	9		POA	1.324	0.946	0.757	0.573
	00546	0.425	3D	10.8		POA	1.490	1.064	0.851	0.636
6BA	00562	0.110	1D	2.8		POA	0.828	0.591	0.473	0.354
	00563	0.165	1.5D	4.2			0.910	0.651	0.520	0.386
	00564	0.220	2D	5.6			1.076	0.769	0.614	0.459
	00565	0.276	2.5D	7		POA	1.324	0.946	0.757	0.573
	00566	0.331	3D	8.4		POA	1.490	1.064	0.851	0.636

BSC		INSTALLED LENGTH				PRICE EACH PER INSERT (100 PER BAG)				
Thread Size	Part No.	inches	D's	mm	POA	100+	500+	1000+	5000+	
5/16 - 26	06502	0.313	1D	8		POA	0.910	0.651	0.520	0.386
	06503	0.470	1.5D	11.9			1.027	0.733	0.587	0.438
	06504	0.626	2D	15.9		POA	1.490	1.064	0.851	0.636
3/8 - 26	06602	0.625	1D	15.9		MIN	1.027	0.733	0.587	0.438
	06603	0.938	1.5D	23.8			1.193	0.851	0.681	0.511
	06604	1.250	2D	31.8		POA	1.655	1.182	0.946	0.709
7/16 - 26	06702	0.438	1D	11.1		POA	1.193	0.851	0.681	0.511
	06703	0.656	1.5D	16.7		POA	1.655	1.182	0.946	0.709
	06704	0.876	2D	22.3		POA	2.317	1.655	1.324	0.990
1/2 - 26	06802	0.500	1D	12.7		POA	2.186	1.562	1.249	0.990
	06803	0.750	1.5D	19.1			2.499	1.785	1.428	1.136
	06804	2.000	2D	50.8		POA	3.280	2.342	1.874	1.491

BSP		INSTALLED LENGTH				PRICE EACH PER INSERT (100 PER BAG)					
Thread Size	Part No.	inches	D's	mm	POA	100+	500+	1000+	5000+		
1/8 - 28	01022	0.125	1D	3.2			1.159	0.828	0.662	0.500	
	01023	0.188	1.5D	4.8			1.357	0.970	0.776	0.584	
	01024	0.250	2D	6.4			1.821	1.301	1.041	0.782	
	01025	0.313	2.5D	7.9			2.152	1.537	1.230	0.928	
		0.125	1D	3.2	1/8 - 27	06023		1.159	0.828	0.662	0.496
		0.188	1.5D	4.8							
		0.250	2D	6.4							
		0.313	2.5D	7.9							
1/4 - 19	01042	0.250	1D	6.4			1.655	1.182	0.946	0.709	
	01043	0.375	1.5D	9.5			1.987	1.419	1.135	0.855	
	01044	0.500	2D	12.7			2.649	1.892	1.514	1.136	
	01045	0.625	2.5D	15.9		POA	2.979	2.129	1.702	1.282	
		0.250	1D	6.4	1/4 - 18	06043		1.655	1.182	0.946	0.710
		0.375	1.5D	9.5							
		0.500	2D	12.7							
		0.625	2.5D	15.9							
3/8 - 19	01062	0.375	1D	9.5			1.821	1.301	1.041	0.782	
	01063	0.563	1.5D	14.3			2.483	1.773	1.419	1.063	
	01064	0.750	2D	19.1			3.477	2.483	1.987	1.491	
	01065	0.938	2.5D	23.8		POA	4.139	2.957	2.364	1.772	
		0.375	1D	9.5	3/8 - 18	06063		1.821	1.301	1.041	0.780
		0.563	1.5D	14.3							
		0.750	2D	19.1							
		0.938	2.5D	23.8							

Bulk Inserts Free Running - BSP/Special Threads/UN/UNC LHT

Only Supplied in Full Bag quantities.

BSP Thread Size	Part No.	INSTALLED LENGTH					PRICE EACH PER INSERT (100 PER BAG)					
		inches	D's	mm			POA	50+	100+	500+	1000+	
1/2 - 14	01082	0.500	1D	12.7				3.228	2.306	1.844	1.387	
	01083	0.750	1.5D	19.1				4.055	2.897	2.317	1.741	
	01084	1.000	2D	25.4			POA	5.298	3.783	3.026	2.273	
	01085	1.250	2.5D	31.8			POA	5.794	4.139	3.311	2.481	
		0.500	1D	12.7	1/2 - 14	06083		3.228	2.306	1.844	1.383	
		0.750	1.5D	19.1								
		1.000	2D	25.4								
		1.250	2.5D	31.8								
5/8 - 14	01102	0.625	1D	15.9			POA	4.801	3.429	2.743	2.054	
	01103	0.938	1.5D	23.8			POA	5.794	4.139	3.311	2.481	
	01104	1.250	2D	31.8			POA	7.283	5.202	4.162	3.128	
3/4 - 14	01122	0.750	1D	19.1				4.966	3.548	2.838	2.127	
	01123	1.125	1.5D	28.6				5.960	4.257	3.406	2.554	
	01124	1.500	2D	38.1			POA	7.614	5.439	4.351	3.263	
			0.750	1D	19.1	3/4 - 14	06123		4.966	3.548	2.838	2.129
		1.125	1.5D	28.6								
		1.500	2D	38.1								

BSP Thread Size	Part No.	INSTALLED LENGTH					PRICE EACH PER INSERT (100 PER BAG)					
		inches	D's	mm			POA	25+	50+	100+	500+	
1" - 11	01162	1.000	1D	25.4				6.208	4.435	3.548	2.658	
	01163	1.500	1.5D	38.1			POA	7.864	5.617	4.493	3.367	
	01164	2.000	2D	50.8			POA	9.600	6.858	5.487	4.118	
		1.000	1D	25.4	1 - 11 1/2	06163		6.209	4.435	3.548	2.660	
		1.500	1.5D	38.1								
		2.000	2D	50.8								

Special Thread Size	Part No.	INSTALLED LENGTH					PRICE EACH PER INSERT (100 PER BAG)				
		inches	D's	mm			POA	100+	500+	1000+	5000+
1/4 - 32	04042-32	0.25	1D	6.4				0.642	0.459	0.367	0.271
	04043-32	0.375	1.5D	9.5				0.725	0.518	0.415	0.313
		0.25	1D	6.4	1/4 - 24	04042-24					
		0.375	1.5D	9.5		04043-24					
HARLEY 7/16 - 16	04073-16	0.657	1.5D	16.7				1.098	0.784	0.627	0.469
CUMMINS 11/16 - 16	04110-16-125	0.86		21.8			POA	4.139	2.957	2.364	1.772
CARBY 7/8 - 20	04140-20-330	0.33		8.4			POA	4.759	3.400	2.720	2.043
1" - 20	04160-20-325	0.325		8.3							

8 TPI UN Thread Size	Part No.	INSTALLED LENGTH					PRICE EACH PER INSERT (100 PER BAG)				
		inches	D's	mm			POA	10+	50+	100+	500+
1 1/8 - 8	06182	1.125	1D	28.6			POA	8.773	6.266	5.013	3.763
	06183	1.688	1.5D	42.9			POA	10.263	7.331	5.864	4.399
	06184	2.25	2D	57.2				11.753	8.395	6.717	5.035
1 1/4 - 8	06202	1.25	1D	31.8			POA	9.932	7.094	5.675	4.253
	06203	1.875	1.5D	47.6				11.587	8.276	6.622	4.962
	06204	2.5	2D	63.5				14.898	10.642	8.513	6.380
1 3/8 - 8	06222	1.375	1D	34.9			POA	11.587	8.276	6.622	4.962
	06223	2.063	1.5D	52.4			POA	12.911	9.223	7.379	5.536
	06224	2.75	2D	69.9			POA	16.554	11.824	9.460	7.099
1 1/2 - 8	06242	1.5	1D	38.1				13.243	9.460	7.568	5.671
	06243	2.25	1.5D	57.2			POA	15.395	10.996	8.798	6.599
	06244	3	2D	76.2			POA	19.865	14.188	11.351	8.517
1 5/8 - 8	06262	1.625	1D	41.3			POA	23.175	16.554	13.243	9.935
	06263	2.438	1.5D	61.9			POA	25.658	18.327	14.662	10.998
	06264	3.25	2D	82.6			POA	33.108	23.648	18.918	14.188
1 3/4 - 8	06282	1.75	1D	44.5			POA	23.175	16.554	13.243	9.935
	06283	2.625	1.5D	66.7			POA	28.969	20.693	16.554	12.416
	06284	3.5	2D	88.9			POA	36.418	26.012	20.810	15.606

Australian Price List Effective May 2013
Note! All prices are exclusive of GST

POA - Price On Application - denotes non-popular parts.

Minimum quantities and order values may apply.

Only supplied in full bag quantities. Dry film lubing and plating available.

Bulk Inserts Free Running - UN/UNC LHT/Bicycle Threads

Only Supplied in Full Bag quantities.



8 TPI UN		INSTALLED LENGTH				PRICE EACH PER INSERT (100 PER BAG)				
Thread Size	Part No.	inches	D's	mm	POA	10+	50+	100+	500+	
1 7/8 - 8	06302	1.875	1D	47.6						
	06303	2.813	1.5D	71.4						
	06304	3.75	2D	95.3						
2" - 8	06322	2	1D	50.8						
	06323	3	1.5D	76.2						
	06324	4	2D	101.6						
2 1/8 - 8	06343	3.188	1.5D	81						
2 1/4 - 8	06362	2.25	1D	57.2						
	06363	3.375	1.5D	85.7						
	06402	2.5	1D	63.5						
2 1/2-8	06403	3.75	1.5D	95.3						
2 3/4-8	06443	2.75	1.5D	69.9						
3" - 8	06482	3	1D	76.2						
	06483	4.5	1.5D	114.3						

UNC Left Hand Thread		INSTALLED LENGTH				PRICE EACH PER INSERT (100 PER BAG)				
Thread Size	Part No.	inches	D's	mm	POA	100+	500+	1000+	5000+	
1/4 - 20	03043LH	0.25	1.5D	6.4						
5/16 - 18	03053LH	0.313	1.5D	8						
3/8 - 16	03063LH	0.375	1.5D	9.5						
7/16 - 14	03073LH	0.438	1.5D	11.1						
1/2 - 13	03083LH	0.5	1.5D	12.7						

Bicycle Threads		INSTALLED LENGTH				PRICE EACH PER INSERT (100 PER BAG)				
Thread Size	Part No.	inches	D's	mm	POA	10+	50+	100+	500+	
9/16 - 20	04090-20-0.5	0.5		12.7						
9/16 - 20	04090LH-20-0.5	0.5		12.7						

Australian Price List Effective May 2013

Note! All prices are exclusive of GST

POA - Price On Application - denotes non-popular parts.

Minimum quantities and order values may apply.

Only supplied in full bag quantities.

Dry film lubing and plating available.

Bulk Inserts Screw Locking - Metric

Only Supplied in Full Bag quantities, except as shown



METRIC COARSE		Insert Length			METRIC FINE		PRICE EACH PER INSERT (100 PER BAG)				
Thread Size	Part No.	inches	Dia	mm	Thread Size	Part No.	POA	100+	500+	1000+	5000+
M2.2 x 0.45	15012	0.087	1D	2.2			POA	0.665	0.476	0.379	0.281
	15013	0.130	1.5D	3.3			POA	0.714	0.510	0.408	0.302
	15014	0.173	2D	4.4			POA	0.738	0.528	0.421	0.313
	15015	0.217	2.5D	5.5			POA	0.813	0.581	0.465	0.344
	15016	0.260	3D	6.6			POA	0.885	0.632	0.506	0.375
M2.5 x 0.45	15252	0.098	1D	2.5				0.604	0.432	0.344	0.261
	15253	0.150	1.5D	3.8				0.642	0.459	0.367	0.271
	15254	0.197	2D	5				0.676	0.484	0.386	0.292
	15255	0.248	2.5D	6.3			POA	0.725	0.518	0.415	0.313
	15256	0.295	3D	7.5			POA	0.813	0.581	0.465	0.344
M3 x 0.5	15032	0.118	1D	3				0.604	0.432	0.344	0.261
	15033	0.177	1.5D	4.5				0.642	0.459	0.367	0.271
	15034	0.236	2D	6				0.676	0.484	0.386	0.292
	15035	0.296	2.5D	7.5			POA	0.725	0.518	0.415	0.313
	15036	0.354	3D	9			POA	0.813	0.581	0.465	0.344
M3.5 x 0.6	15352	0.138	1D	3.5			POA	0.640	0.457	0.366	0.271
	15353	0.209	1.5D	5.3				0.689	0.492	0.393	0.292
	15354	0.276	2D	7			POA	0.738	0.528	0.421	0.313
	15355	0.346	2.5D	8.8			POA	0.813	0.581	0.465	0.344
	15356	0.413	3D	10.5			POA	0.885	0.632	0.506	0.375
M4 x 0.7	15042	0.157	1D	4				0.604	0.432	0.344	0.261
	15043	0.236	1.5D	6				0.642	0.459	0.367	0.271
	15044	0.315	2D	8				0.676	0.484	0.386	0.292
	15045	0.394	2.5D	10			POA	0.725	0.518	0.415	0.313
	15046	0.472	3D	12			POA	0.813	0.581	0.465	0.344
M5 x 0.8	15052	0.197	1D	5				0.604	0.432	0.344	0.261
	15053	0.295	1.5D	7.5				0.642	0.459	0.367	0.271
	15054	0.394	2D	10				0.676	0.484	0.386	0.292
	15055	0.492	2.5D	12.5			POA	0.763	0.545	0.437	0.323
	15056	0.591	3D	15			POA	0.862	0.615	0.492	0.375
M6 x 1	15062	0.236	1D	6				0.661	0.472	0.376	0.281
	15063	0.354	1.5D	9				0.725	0.518	0.415	0.313
	15064	0.472	2D	12				0.763	0.545	0.437	0.323
	15065	0.591	2.5D	15			POA	0.828	0.591	0.473	0.354
	15066	0.709	3D	18			POA	0.906	0.647	0.518	0.386
M7 x 1	15072	0.276	1D	7			POA	0.676	0.484	0.386	0.292
	15073	0.413	1.5D	10.5			POA	0.792	0.567	0.453	0.344
	15074	0.551	2D	14			POA	0.873	0.624	0.497	0.375
	15075	0.689	2.5D	17.5			POA	1.085	0.775	0.620	0.469
	15076	0.827	3D	21			POA	1.294	0.924	0.739	0.553
M8 x 1.25	15082	0.315	1D	8				0.698	0.500	0.400	0.302
	15083	0.472	1.5D	12				0.792	0.567	0.453	0.344
	15084	0.630	2D	16				0.873	0.624	0.497	0.375
	15085	0.787	2.5D	20			POA	1.085	0.775	0.620	0.469
	15086	0.945	3D	24			POA	1.294	0.924	0.739	0.553
		0.315	1D	8	M8 x 1	17082		0.698	0.500	0.400	0.302
		0.472	1.5D	12		17083	POA	0.792	0.567	0.453	0.344
		0.630	2D	16		17084	POA	0.873	0.624	0.497	0.375
		0.787	2.5D	20		17085	POA	1.085	0.775	0.620	0.469
		0.945	3D	24		17086	POA	1.294	0.924	0.739	0.553
		0.315	1D	8	M8 x 0.75	18082	POA	0.982	0.703	0.561	0.417
		0.472	1.5D	12		18083	POA	1.112	0.795	0.637	0.480
		0.630	2D	16		18084	POA	1.269	0.906	0.725	0.542
		0.787	2.5D	20		18085	POA	1.526	1.091	0.873	0.657
		0.945	3D	24		18086	POA	1.810	1.294	1.034	0.771

Australian Price List Effective May 2013
Note! All prices are exclusive of GST

POA - Price On Application - denotes non-popular parts.

Minimum quantities and order values may apply.

Only supplied in full bag quantities. Dry film lubing and plating available.

Bulk Inserts Screw Locking - Metric

Only Supplied in Full Bag quantities, except as shown

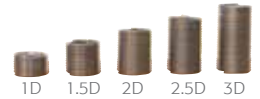

METRIC COARSE		Insert Length			METRIC FINE		PRICE EACH PER INSERT (100 PER BAG)				
Thread Size	Part No.	inches	Dia	mm	Thread Size	Part No.	POA	100+	500+	1000+	5000+
M10 x 1.5	15102	0.394	1D	10.0				0.982	0.702	0.561	0.417
	15103	0.591	1.5D	15.0				1.112	0.795	0.637	0.480
	15104	0.787	2D	20.0				1.269	0.906	0.725	0.542
	15105	0.984	2.5D	25.0				1.526	1.091	0.873	0.657
	15106	1.181	3D	30.0				1.810	1.294	1.034	0.771
		0.394	1D	10.0	M10 x 1.25	17102	POA	0.982	0.702	0.561	0.417
		0.591	1.5D	15.0		17103		1.112	0.795	0.637	0.480
		0.787	2D	20.0		17104	POA	1.269	0.906	0.725	0.542
		0.984	2.5D	25.0		17105	POA	1.526	1.091	0.873	0.657
		1.181	3D	30.0		17106	POA	1.810	1.294	1.034	0.771
		0.394	1D	10.0	M10 x 1	18102	POA	0.982	0.703	0.561	0.417
		0.591	1.5D	15.0		18103	POA	1.112	0.795	0.637	0.480
		0.787	2D	20.0		18104	POA	1.269	0.906	0.725	0.542
		0.984	2.5D	25.0		18105	POA	1.526	1.091	0.873	0.657
		1.181	3D	30.0		18106	POA	1.810	1.294	1.034	0.771
M12 x 1.75	15122	0.472	1D	12.0				1.437	1.027	0.821	0.615
	15123	0.709	1.5D	18.0				1.552	1.109	0.887	0.667
	15124	0.945	2D	24.0				1.810	1.294	1.034	0.771
	15125	1.181	2.5D	30.0				2.328	1.662	1.330	1.001
	15126	1.417	3D	36.0			POA	2.586	1.847	1.478	1.105
		0.472	1D	12.0	M12 x 1.5	17122	POA	1.437	1.027	0.821	0.615
		0.709	1.5D	18.0		17123	POA	1.552	1.109	0.887	0.667
		0.945	2D	24.0		17124	POA	1.810	1.294	1.034	0.771
		1.181	2.5D	30.0		17125	POA	2.328	1.662	1.330	1.001
		1.417	3D	36.0		17126	POA	2.586	1.847	1.478	1.105
		0.472	1D	12.0	M12 x 1.25	18122	POA	1.437	1.027	0.821	0.615
		0.709	1.5D	18.0		18123		1.552	1.109	0.887	0.667
		0.945	2D	24.0		18124	POA	1.810	1.294	1.034	0.771
		1.181	2.5D	30.0		18125	POA	2.328	1.662	1.330	1.001
		1.417	3D	36.0		18126	POA	2.586	1.847	1.478	1.105

METRIC COARSE		Insert Length			METRIC FINE		PRICE EACH PER INSERT (100 PER BAG)				
Thread Size	Part No.	inches	Dia	mm	Thread Size	Part No.	POA	50+	100+	500+	1000+
M14 x 2	15142	0.551	1D	14.0				1.916	1.370	1.095	0.824
	15143	0.827	1.5D	21.0				2.459	1.756	1.404	1.053
	15144	1.102	2D	28.0			POA	3.073	2.194	1.756	1.314
	15145	1.378	2.5D	35.0			POA	3.811	2.723	2.177	1.637
	15146	1.654	3D	42.0			POA	4.423	3.161	2.528	1.897
		0.551	1D	14.0	M14 x 1.5	17142	POA	1.916	1.370	1.095	0.824
		0.827	1.5D	21.0		17143		2.459	1.756	1.404	1.053
		1.102	2D	28.0		17144	POA	3.073	2.194	1.756	1.314
		1.378	2.5D	35.0		17145	POA	3.811	2.723	2.177	1.637
		1.654	3D	42.0		17146	POA	4.423	3.161	2.528	1.897
M16 x 2	15162	0.630	1D	16.0				2.459	1.756	1.404	1.053
	15163	0.945	1.5D	24.0				3.026	2.162	1.730	1.303
	15164	1.260	2D	32.0				3.880	2.771	2.216	1.658
	15165	1.575	2.5D	40.0			POA	4.657	3.327	2.660	1.991
	15166	1.890	3D	48.0			POA	5.432	3.880	3.105	2.325
		0.630	1D	16.0	M16 x 1.5	17162		2.459	1.756	1.404	1.053
		0.945	1.5D	24.0		17163	POA	3.026	2.162	1.730	1.303
		1.260	2D	32.0		17164	POA	3.880	2.771	2.216	1.658
		1.575	2.5D	40.0		17165	POA	4.657	3.327	2.660	1.991
		1.890	3D	48.0		17166	POA	5.432	3.880	3.105	2.325

Australian Price List Effective May 2013

Note! All prices are exclusive of GST

POA - Price On Application - denotes non-popular parts.

Minimum quantities and order values may apply.

Only supplied in full bag quantities.

Dry film lubing and plating available.

Bulk Inserts Screw Locking - Metric

Only Supplied in Full Bag quantities, except as shown



METRIC COARSE		Insert Length			METRIC FINE		PRICE EACH PER INSERT (100 PER BAG)				
Thread Size	Part No.	inches	Dia	mm	Thread Size	Part No.	POA	50+	100+	500+	1000+
M18 x 2.5	15182	0.709	1D	18.0			POA	3.516	2.511	2.009	1.512
	15183	1.063	1.5D	27.0				4.139	2.957	2.364	1.772
	15184	1.417	2D	36.0			POA	5.432	3.880	3.105	2.325
	15185	1.772	2.5D	45.0			POA	6.725	4.804	3.844	2.888
	15186	2.126	3D	54.0			POA	8.018	5.727	4.582	3.440
		0.709	1D	18.0	M18 x 2	17182	POA	3.516	2.511	2.009	1.512
		1.063	1.5D	27.0		17183	POA	4.139	2.957	2.364	1.772
		1.417	2D	36.0		17184	POA	5.432	3.880	3.105	2.325
		1.772	2.5D	45.0		17185	POA	6.725	4.804	3.844	2.888
		2.126	3D	54.0		17186	POA	8.018	5.727	4.582	3.440

METRIC COARSE		Insert Length			METRIC FINE		PRICE EACH PER INSERT (100 PER BAG)				
Thread Size	Part No.	inches	Dia	mm	Thread Size	Part No.	POA	25+	50+	100+	500+
M20 x 2.5	15202	0.787	1D	20.0				4.914	3.511	2.807	2.106
	15203	1.181	1.5D	30.0				5.691	4.066	3.253	2.439
	15204	1.575	2D	40.0			POA	6.467	4.618	3.696	2.773
	15205	1.969	2.5D	50.0			POA	7.128	5.089	4.072	3.055
	15206	2.362	3D	60.0			POA	8.356	5.968	4.775	3.586
		0.787	1D	20.0	M20 x 2	17202	POA	4.914	3.511	2.807	2.106
		1.181	1.5D	30.0		17203	POA	5.691	4.066	3.253	2.439
		1.575	2D	40.0		17204		6.467	4.618	3.696	2.773
		1.969	2.5D	50.0		17205	POA	7.128	5.089	4.072	3.055
		2.362	3D	60.0		17206	POA	8.356	5.968	4.775	3.586
M22 x 2.5	15222	0.866	1D	22.0			POA	6.208	4.435	3.548	2.658
	15223	1.299	1.5D	33.0				7.113	5.082	4.066	3.055
	15224	1.732	2D	44.0			POA	8.276	5.912	4.730	3.545
	15225	2.165	2.5D	55.0			POA	9.708	6.936	5.546	4.160
	15226	2.598	3D	66.0			POA	11.304	8.074	6.459	4.848
		0.866	1D	22.0	M22 x 2	17222	POA	6.208	4.435	3.548	2.658
		1.299	1.5D	33.0		17223	POA	7.113	5.082	4.066	3.055
		1.732	2D	44.0		17224	POA	8.276	5.912	4.730	3.545
		2.165	2.5D	55.0		17225	POA	9.708	6.936	5.546	4.160
		2.598	3D	66.0		17226	POA	11.304	8.074	6.459	4.848
M24 x 3	15242	0.945	1D	24.0				7.759	5.543	4.435	3.326
	15243	1.417	1.5D	36.0				8.796	6.282	5.026	3.774
	15244	1.890	2D	48.0			POA	10.087	7.206	5.764	4.326
	15245	2.362	2.5D	60.0			POA	12.157	8.683	6.946	5.213
	15246	2.835	3D	72.0			POA	13.709	9.792	7.833	5.880
		0.945	1D	24.0	M24 x 2	17242	POA	7.759	5.543	4.435	3.326
		1.417	1.5D	36.0		17243	POA	8.796	6.282	5.026	3.774
		1.890	2D	48.0		17244	POA	10.087	7.206	5.764	4.326
		2.362	2.5D	60.0		17245	POA	12.157	8.683	6.946	5.213
		2.835	3D	72.0		17246	POA	13.709	9.792	7.833	5.880

METRIC COARSE		Insert Length			METRIC FINE		PRICE EACH PER INSERT (100 PER BAG)				
Thread Size	Part No.	inches	Dia	mm	Thread Size	Part No.	POA	10+	50+	100+	500+
M27 x 3	15272	1.063	1D	27.0				11.304	8.074	6.459	4.848
	15273	1.594	1.5D	40.5				13.271	9.478	7.583	5.692
	15274	2.126	2D	54.0				15.482	11.059	8.846	6.630
	15275	2.657	2.5D	67.5				18.106	12.933	10.347	7.756
	15276	3.189	3D	81.0				20.693	14.781	11.824	8.872

Australian Price List Effective May 2013

Note! All prices are exclusive of GST

POA - Price On Application - denotes non-popular parts.

Minimum quantities and order values may apply.

Only supplied in full bag quantities.

Dry film lubing and plating available.

Bulk Inserts Screw Locking - Metric

Only Supplied in Full Bag quantities, except as shown



METRIC COARSE		Insert Length			METRIC FINE		PRICE EACH PER INSERT (100 PER BAG)				
Thread Size	Part No.	inches	Dia	mm	Thread Size	Part No.	POA	10+	50+	100+	500+
		1.063	1D	27.0	M27 x 2	17272	POA	11.304	8.074	6.459	4.848
		1.594	1.5D	40.5		17273	POA	13.271	9.478	7.583	5.692
		2.126	2D	54.0		17274	POA	15.482	11.059	8.846	6.630
		2.657	2.5D	67.5		17275	POA	18.106	12.933	10.347	7.756
		3.189	3D	81.0		17276	POA	20.693	14.781	11.824	8.872
M30 x 3.5	15302	1.181	1D	30.0			POA	14.744	10.530	8.424	6.318
	15303	1.772	1.5D	45.0			POA	14.744	10.530	8.424	6.318
	15304	2.362	2D	60.0			POA	17.446	12.463	9.968	7.475
	15305	2.953	2.5D	75.0			POA	20.693	14.781	11.824	8.872
	15306	3.543	3D	90.0			POA	23.279	16.628	13.302	9.977
		1.181	1D	30.0	M30 x 2	17302	POA	14.744	10.530	8.424	6.318
		1.772	1.5D	45.0		17303	POA	14.744	10.530	8.424	6.318
		2.362	2D	60.0		17304	POA	17.446	12.463	9.968	7.475
		2.953	2.5D	75.0		17305	POA	20.693	14.781	11.824	8.872
		3.543	3D	90.0		17306	POA	23.279	16.628	13.302	9.977
M30 x 3	15302-3	1.181	1D	30.0			POA	12.286	8.778	7.021	5.265
	15303-3	1.772	1.5D	45.0			POA	14.744	10.530	8.424	6.318
	15304-3	2.362	2D	60.0			POA	17.446	12.463	9.968	7.475
	15305-3	2.953	2.5D	75.0			POA	20.693	14.781	11.824	8.872
	15306-3	3.543	3D	90.0			POA	23.279	16.628	13.302	9.977
M36 x 4	15362	1.417	1D	36.0			POA	15.520	11.085	8.869	6.651
	15363	2.126	1.5D	54.0			POA	18.106	12.933	10.347	7.756
	15364	2.835	2D	72.0			POA	23.279	16.628	13.302	9.977
	15365	3.543	2.5D	90.0			POA	28.452	20.322	16.259	12.197
	15366	4.252	3D	108.0			POA	33.626	24.018	19.214	14.407
		1.417	1D	36.0	M36 x 3	17362	POA	15.520	11.085	8.869	6.651
		2.126	1.5D	54.0		17363	POA	18.106	12.933	10.347	7.756
		2.835	2D	72.0		17364	POA	23.279	16.628	13.302	9.977
		3.543	2.5D	90.0		17365	POA	28.452	20.322	16.259	12.197
		4.252	3D	108.0		17366	POA	33.626	24.018	19.214	14.407
M39 x 4	15392	1.535	1D	39.0			POA	16.812	12.009	9.608	7.204
	15393	2.303	1.5D	58.5			POA	20.693	14.781	11.824	8.872
	15394	3.071	2D	78.0			POA	25.864	18.475	14.781	11.082
		1.535	1D	39.0	M39 x 3	17392	POA	16.812	12.009	9.608	7.204
		2.303	1.5D	58.5		17393	POA	20.693	14.781	11.824	8.872
		3.071	2D	78.0		17394	POA	25.864	18.475	14.781	11.082

Australian Price List Effective May 2013

Note! All prices are exclusive of GST

POA - Price On Application - denotes non-popular parts.

Minimum quantities and order values may apply.

Only supplied in full bag quantities.

Dry film lubing and plating available.

Bulk Inserts Screw Locking - UNC/UNF

Only Supplied in Full Bag quantities, except as shown



UNC Thread Size	Part No.	Insert Length			UNF Thread Size	Part No.	PRICE EACH PER INSERT (100 PER BAG)				
		inches	Dia	mm			POA	100+	500+	1000+	5000+
#2 - 56	13522	0.086	1D	2.2				0.776	0.555	0.443	0.334
	13523	0.129	1.5D	3.3				0.841	0.603	0.480	0.365
	13524	0.172	2D	4.4				0.880	0.628	0.502	0.375
	13525	0.215	2.5D	5.5				0.932	0.665	0.533	0.396
	13526	0.258	3D	6.6			POA	1.024	0.731	0.585	0.438
#3 - 48	13532	0.099	1D	2.5			POA	1.294	0.924	0.739	0.553
	13533	0.149	1.5D	3.8				1.397	0.998	0.798	0.594
	13534	0.198	2D	5				1.475	1.053	0.843	0.636
	13535	0.248	2.5D	6.3			POA	1.552	1.109	0.887	0.667
	13536	0.297	3D	7.5			POA	1.708	1.219	0.976	0.730
		0.099	1D	2.5	#3 - 56	14532	POA	1.294	0.924	0.739	0.553
		0.149	1.5D	3.8		14533	POA	1.397	0.998	0.798	0.594
		0.198	2D	5		14534	POA	1.475	1.053	0.843	0.636
		0.248	2.5D	6.3							
		0.297	3D	7.5							
#4 - 40	13542	0.112	1D	2.8				0.595	0.425	0.340	0.250
	13543	0.168	1.5D	4.3				0.634	0.455	0.362	0.271
	13544	0.224	2D	5.7				0.673	0.480	0.385	0.292
	13545	0.280	2.5D	7.1				0.725	0.518	0.415	0.313
	13546	0.336	3D	8.5				0.776	0.555	0.443	0.334
		0.112	1D	2.8	#4 - 48	14542	POA	0.595	0.425	0.340	0.261
		0.168	1.5D	4.3		14543	POA	0.634	0.455	0.362	0.271
		0.224	2D	5.7		14544		0.673	0.480	0.385	0.292
		0.280	2.5D	7.1							
		0.336	3D	8.5							
#5 - 40	13552	0.125	1D	3.2				0.595	0.425	0.340	0.250
	13553	0.188	1.5D	4.8				0.634	0.455	0.362	0.271
	13554	0.250	2D	6.4			POA	0.673	0.480	0.385	0.292
	13555	0.313	2.5D	7.9			POA	0.725	0.518	0.415	0.313
	13556	0.375	3D	9.5				0.776	0.555	0.443	0.334
#6 - 32	13562	0.138	1D	3.5				0.595	0.425	0.340	0.250
	13563	0.207	1.5D	5.3				0.634	0.455	0.362	0.271
	13564	0.276	2D	7				0.673	0.480	0.385	0.292
	13565	0.345	2.5D	8.8				0.725	0.518	0.415	0.313
	13566	0.414	3D	10.5				0.776	0.555	0.443	0.334
		0.138	1D	3.5	#6 - 40	14562	POA	0.595	0.425	0.340	0.261
		0.207	1.5D	5.3		14563		0.634	0.455	0.362	0.271
		0.276	2D	7		14564		0.673	0.480	0.385	0.292
		0.345	2.5D	8.8							
		0.414	3D	10.5							
#8 - 32	13582	0.164	1D	4.2				0.595	0.425	0.340	0.250
	13583	0.246	1.5D	6.2				0.634	0.455	0.362	0.271
	13584	0.328	2D	8.3				0.673	0.480	0.385	0.292
	13585	0.410	2.5D	10.4				0.725	0.518	0.415	0.313
	13586	0.492	3D	12.5				0.776	0.555	0.443	0.334
		0.164	1D	4.2	#8 - 36	14582		0.595	0.425	0.340	0.261
		0.246	1.5D	6.2		14583		0.634	0.455	0.362	0.271
		0.328	2D	8.3		14584	POA	0.673	0.480	0.385	0.292
		0.410	2.5D	10.4							
		0.492	3D	12.5							
#10 - 24	13602	0.190	1D	4.8				0.595	0.425	0.340	0.250
	13603	0.285	1.5D	7.2				0.634	0.455	0.362	0.271
	13604	0.380	2D	9.7				0.673	0.480	0.385	0.292
	13605	0.475	2.5D	12.1			POA	0.725	0.518	0.415	0.313
	13606	0.570	3D	14.5				0.776	0.555	0.443	0.334

Bulk Inserts Screw Locking - UNC/UNF

Only Supplied in Full Bag quantities, except as shown



UNC Thread Size	Part No.	Insert Length			UNF Thread Size	Part No.	POA	PRICE EACH PER INSERT (100 PER BAG)			
		inches	Dia	mm				100+	500+	1000+	5000+
#10 - 32		0.190	1D	4.8		14602		0.595	0.425	0.340	0.261
		0.285	1.5D	7.2		14603		0.634	0.455	0.362	0.271
		0.380	2D	9.7		14604		0.673	0.480	0.385	0.292
		0.475	2.5D	12.1		14605		0.725	0.518	0.415	0.313
		0.570	3D	14.5		14606		0.776	0.555	0.443	0.334
#12 - 24	13622	0.216	1D	5.5				0.686	0.491	0.391	0.292
	13623	0.324	1.5D	8.2			POA	0.713	0.509	0.407	0.302
	13624	0.432	2D	11			POA	0.804	0.573	0.459	0.344
	13625	0.540	2.5D	13.7			POA	0.855	0.610	0.489	0.365
	13626	0.648	3D	16.5			POA	0.932	0.665	0.533	0.396
1/4 - 20	13042	0.250	1D	6.4				0.686	0.491	0.391	0.292
	13043	0.375	1.5D	9.5				0.713	0.509	0.407	0.302
	13044	0.500	2D	12.7				0.804	0.573	0.459	0.344
	13045	0.625	2.5D	15.9				0.855	0.610	0.489	0.365
	13046	0.750	3D	19.1				0.932	0.665	0.533	0.396
1/4 - 28		0.250	1D	6.4		14042		0.686	0.491	0.391	0.292
		0.375	1.5D	9.5		14043		0.713	0.509	0.407	0.302
		0.500	2D	12.7		14044		0.804	0.573	0.459	0.344
		0.625	2.5D	15.9		14045	POA	0.855	0.610	0.489	0.365
		0.750	3D	19.1		14046	POA	0.932	0.665	0.533	0.396
5/16 - 18	13052	0.313	1D	8				0.751	0.537	0.428	0.323
	13053	0.470	1.5D	11.9				0.790	0.565	0.450	0.334
	13054	0.626	2D	15.9				0.867	0.620	0.495	0.375
	13055	0.783	2.5D	19.9			POA	0.982	0.703	0.561	0.417
	13056	0.939	3D	23.9			POA	1.112	0.795	0.637	0.480
5/16 - 24		0.313	1D	8		14052		0.751	0.537	0.428	0.323
		0.470	1.5D	11.9		14053		0.790	0.565	0.450	0.334
		0.626	2D	15.9		14054		0.867	0.620	0.495	0.375
		0.783	2.5D	19.9		14055		0.982	0.703	0.561	0.417
		0.939	3D	23.9		14056	POA	1.112	0.795	0.637	0.480
3/8 - 16	13062	0.375	1D	9.5				1.010	0.721	0.577	0.438
	13063	0.563	1.5D	14.3				1.112	0.795	0.637	0.480
	13064	0.750	2D	19.1				1.294	0.924	0.739	0.553
	13065	0.938	2.5D	23.8			POA	1.475	1.053	0.843	0.636
	13066	1.125	3D	28.6				1.683	1.201	0.961	0.719
3/8 - 24		0.375	1D	9.5		14062		1.010	0.721	0.577	0.438
		0.563	1.5D	14.3		14063		1.112	0.795	0.637	0.480
		0.750	2D	19.1		14064		1.294	0.924	0.739	0.553
		0.938	2.5D	23.8		14065	POA	1.475	1.053	0.843	0.636
		1.125	3D	28.6		14066	POA	1.683	1.201	0.961	0.719
7/16 - 14	13072	0.438	1D	11.1				1.242	0.887	0.710	0.532
	13073	0.657	1.5D	16.7				1.320	0.943	0.755	0.563
	13074	0.876	2D	22.3				1.475	1.053	0.843	0.636
	13075	1.095	2.5D	27.8				1.810	1.294	1.034	0.771
	13076	1.314	3D	33.4				2.069	1.478	1.182	0.886
7/16 - 20		0.438	1D	11.1		14072		1.242	0.887	0.710	0.532
		0.657	1.5D	16.7		14073		1.320	0.943	0.755	0.563
		0.876	2D	22.3		14074		1.475	1.053	0.843	0.636
		1.095	2.5D	27.8		14075		1.810	1.294	1.034	0.771
		1.314	3D	33.4		14076		2.069	1.478	1.182	0.886
1/2 - 13	13082	0.500	1D	12.7				1.423	1.016	0.813	0.615
	13083	0.750	1.5D	19.1				1.514	1.082	0.864	0.646
	13084	1.000	2D	25.4				1.708	1.219	0.976	0.730
	13085	1.250	2.5D	31.8				2.069	1.478	1.182	0.886
	13086	1.500	3D	38.1				2.459	1.756	1.404	1.053

Bulk Inserts Screw Locking - UNC/UNF

Only Supplied in Full Bag quantities, except as shown



UNC		Insert Length			UNF		PRICE EACH PER INSERT (100 PER BAG)				
Thread Size	Part No.	inches	Dia	mm	Thread Size	Part No.	POA	100+	500+	1000+	5000+
		0.500	1D	12.7	1/2 - 20	14082		1.423	1.016	0.813	0.615
		0.750	1.5D	19.1		14083		1.514	1.082	0.864	0.646
		1.000	2D	25.4		14084		1.708	1.219	0.976	0.730
		1.250	2.5D	31.8		14085		2.069	1.478	1.182	0.886
		1.500	3D	38.1		14086		2.459	1.756	1.404	1.053

UNC		Insert Length			UNF		PRICE EACH PER INSERT (100 PER BAG)					
Thread Size	Part No.	inches	Dia	mm	Thread Size	Part No.	POA	50+	100+	500+	1000+	
9/16 - 12	13092	0.56	1D	14.30	9/16 - 18			1.810	1.294	1.034	0.771	
	13093	0.85	1.5D	21.50				2.069	1.478	1.182	0.886	
	13094	1.13	2D	28.60			14092		1.810	1.294	1.034	0.771
	13095	1.41	2.5D	35.80			14093	POA	2.069	1.478	1.182	0.886
	13096	1.69	3D	42.90			14094	POA	2.975	2.126	1.700	1.272
		0.56	1D	14.30			14095	POA	3.752	2.680	2.143	1.605
		0.85	1.5D	21.50			14096	POA	4.528	3.234	2.586	1.939
		1.13	2D	28.60					2.431	1.737	1.389	1.043
		1.41	2.5D	35.80					2.975	2.126	1.700	1.272
		1.69	3D	42.90					3.777	2.697	2.158	1.616
5/8 - 11	13102	0.63	1D	15.90	5/8 - 18			4.553	3.253	2.601	1.949	
	13103	0.94	1.5D	23.80				5.432	3.880	3.105	2.325	
	13104	1.25	2D	31.80			14102		2.431	1.737	1.389	1.043
	13105	1.56	2.5D	39.70			14103		2.975	2.126	1.700	1.272
	13106	1.88	3D	47.60			14104	POA	3.777	2.697	2.158	1.616
		0.63	1D	15.90			14105	POA	4.553	3.253	2.601	1.949
		0.94	1.5D	23.80			14106	POA	5.432	3.880	3.105	2.325
		1.25	2D	31.80					3.493	2.495	1.995	1.501
		1.56	2.5D	39.70					4.126	2.948	2.358	1.772
		1.88	3D	47.60					5.432	3.880	3.105	2.325
3/4 - 10	13122	0.69	1D	17.50	3/4 - 16			6.622	4.730	3.783	2.836	
	13123	1.03	1.5D	26.20				7.759	5.543	4.435	3.326	
	13124	1.38	2D	35.00			14122		3.493	2.495	1.995	1.501
	13125	1.72	2.5D	43.70			14123	POA	4.126	2.948	2.358	1.772
	13126	2.06	3D	52.40			14124		5.432	3.880	3.105	2.325
		0.69	1D	17.50			14125		6.622	4.730	3.783	2.836
		1.03	1.5D	26.20			14126	POA	7.759	5.543	4.435	3.326
		1.38	2D	35.00								
		1.72	2.5D	43.70								
		2.06	3D	52.40								

UNC		Insert Length			UNF		PRICE EACH PER INSERT (100 PER BAG)					
Thread Size	Part No.	inches	Dia	mm	Thread Size	Part No.	POA	25+	50+	100+	500+	
7/8 - 9	13142	0.75	1D	19.10	7/8 - 14			5.949	4.250	3.400	2.554	
	13143	1.13	1.5D	28.60				6.983	4.988	3.991	2.992	
	13144	1.50	2D	38.10				8.018	5.727	4.582	3.440	
	13145	1.88	2.5D	47.60				9.053	6.467	5.173	3.878	
		0.75	1D	19.10			14142	POA	5.949	4.250	3.400	2.554
		1.13	1.5D	28.60			14143	POA	6.983	4.988	3.991	2.992
		1.50	2D	38.10			14144	POA	8.018	5.727	4.582	3.440
		1.88	2.5D	47.60			14145	POA	9.053	6.467	5.173	3.878
1" - 8	13162	0.88	1D	22.20					7.631	5.451	4.361	3.273
	13163	1.31	1.5D	33.30					8.796	6.282	5.026	3.774
	13164	1.75	2D	44.50				10.087	7.206	5.764	4.326	
	13165	2.19	2.5D	55.60			POA	11.898	8.498	6.799	5.098	
	13166	2.63	3D	66.70			POA	13.449	9.608	7.685	5.765	

Australian Price List Effective May 2013
Note! All prices are exclusive of GST

POA - Price On Application - denotes non-popular parts.

Minimum quantities and order values may apply.

Only supplied in full bag quantities. Dry film lubing and plating available.

Bulk Inserts Screw Locking - UNC/UNF

Only Supplied in Full Bag quantities, except as shown



UNC		Insert Length			UNF		PRICE EACH PER INSERT (100 PER BAG)				
Thread Size	Part No.	inches	Dia	mm	Thread Size	Part No.	POA	25+	50+	100+	500+
		0.88	1D	22.20	1" - 12	14162	POA	7.631	5.451	4.361	3.273
		1.31	1.5D	33.30		14163	POA	8.796	6.282	5.026	3.774
		1.75	2D	44.50		14164	POA	10.087	7.206	5.764	4.326
		2.19	2.5D	55.60		14165	POA	11.898	8.498	6.799	5.098
		2.63	3D	66.70		14166	POA	13.449	9.608	7.685	5.765
		1.00	1D	25.40	1" - 14	14162-14	POA	7.631	5.451	4.361	3.273
		1.50	1.5D	38.10		14163-14	POA	8.796	6.282	5.026	3.774
		2.00	2D	50.80		14164-14	POA	10.087	7.206	5.764	4.326
		2.50	2.5D	63.50		14165-14	POA	11.898	8.498	6.799	5.098
		3.00	3D	76.20		14166-14	POA	13.449	9.608	7.685	5.765

UNC		Insert Length			UNF		PRICE EACH PER INSERT (100 PER BAG)				
Thread Size	Part No.	inches	Dia	mm	Thread Size	Part No.	POA	10+	50+	100+	500+
1 1/8 - 7	13182	1.13	1D	28.60				12.286	8.778	7.021	5.265
	13183	1.69	1.5D	42.90				12.933	9.239	7.390	5.546
	13184	2.25	2D	57.20				17.201	12.286	9.830	7.370
		1.13	1D	28.60	1 1/8 - 12	14182	POA	12.286	8.778	7.021	5.265
		1.69	1.5D	42.90		14183	POA	12.933	9.239	7.390	5.546
		2.25	2D	57.20		14184	POA	17.201	12.286	9.830	7.370
		2.81	2.5D	71.40		14185	POA	19.657	14.040	11.233	8.423
		3.38	3D	85.70		14186	POA	22.116	15.797	12.637	9.476
1 1/4 - 7	13202	1.25	1D	31.80				13.515	9.655	7.722	5.796
	13203	1.88	1.5D	47.60				14.744	10.530	8.424	6.318
	13204	2.50	2D	63.50				18.429	13.165	10.530	7.902
	13205	3.13	2.5D	79.40				22.116	15.797	12.637	9.476
	13206	3.75	3D	95.30				24.572	17.552	14.040	10.529
		1.25	1D	31.80	1 1/4 - 12	14202	POA	13.515	9.655	7.722	5.796
		1.88	1.5D	47.60		14203	POA	14.744	10.530	8.424	6.318
		2.50	2D	63.50		14204	POA	18.429	13.165	10.530	7.902
		3.13	2.5D	79.40		14205	POA	22.116	15.797	12.637	9.476
		3.75	3D	95.30		14206	POA	24.572	17.552	14.040	10.529
1 3/8 - 6	13222	1.38	1D	34.90				14.744	10.530	8.424	6.318
	13223	2.06	1.5D	52.40				15.520	11.085	8.869	6.651
	13224	2.75	2D	69.90				22.116	15.797	12.637	9.476
	13225	3.44	2.5D	87.30				27.030	19.307	15.446	11.582
	13226	4.13	3D	104.80				29.487	21.063	16.850	12.635
		1.38	1D	34.90	1 3/8 - 12	14222	POA	14.744	10.530	8.424	6.318
		2.06	1.5D	52.40		14223	POA	15.520	11.085	8.869	6.651
		2.75	2D	69.90		14224	POA	22.116	15.797	12.637	9.476
		3.44	2.5D	87.30		14225	POA	27.030	19.307	15.446	11.582
		4.13	3D	104.80		14226	POA	29.487	21.063	16.850	12.635
1 1/2 - 6	13242	1.50	1D	38.10				17.201	12.286	9.830	7.370
	13243	2.25	1.5D	57.20				20.693	14.781	11.824	8.872
	13244	3.00	2D	76.20				27.030	19.307	15.446	11.582
	13245	3.75	2.5D	95.30				34.401	24.572	19.657	14.741
	13246	4.50	3D	114.30				39.316	28.083	22.466	16.847
		1.50	1D	38.10	1 1/2 - 12	14242	POA	17.201	12.286	9.830	7.370
		2.25	1.5D	57.20		14243	POA	20.693	14.781	11.824	8.872
		3.00	2D	76.20		14244	POA	27.030	19.307	15.446	11.582
		3.75	2.5D	95.30		14245	POA	34.401	24.572	19.657	14.741
		4.50	3D	114.30		14246	POA	39.316	28.083	22.466	16.847

Australian Price List Effective May 2013
 Note! All prices are exclusive of GST
 POA - Price On Application - denotes non-popular parts.

Minimum quantities and order values may apply.
 Only supplied in full bag quantities.
 Dry film lubing and plating available.

Bulk Inserts Screw Locking - 8 TPI UN

Only Supplied in Full Bag quantities, except as shown



8 TPI UN Thread Size	Part No.	Insert Length			PRICE EACH PER INSERT (100 PER BAG)					
		inches	Dia	mm	POA	10+	50+	100+	500+	
1 1/8 - 8	16182	1.13	1D	28.60		POA	10.966	7.833	6.266	4.702
	16183	1.69	1.5D	42.90		POA	12.830	9.165	7.331	5.494
	16184	2.25	2D	57.20		POA	14.692	10.494	8.395	6.297
1 1/4 - 8	16202	1.25	1D	31.80		POA	12.415	8.869	7.094	5.317
	16203	1.88	1.5D	47.60		POA	14.484	10.347	8.276	6.213
	16204	2.50	2D	63.50		PAO	18.623	13.302	10.642	7.986
1 3/8 - 8	16222	1.38	1D	34.90		PAO	14.484	10.347	8.276	6.213
	16223	2.06	1.5D	52.40		POA	16.140	11.529	9.223	6.922
	16224	2.75	2D	69.90		POA	20.693	14.781	11.824	8.872
1 1/2 - 8	16242	1.50	1D	38.10		PAO	16.554	11.824	9.460	7.099
	16243	2.25	1.5D	57.20		POA	19.244	13.745	10.996	8.246
	16244	3.00	2D	76.20		PAO	24.830	17.736	14.188	10.644
1 5/8 - 8	16262	1.63	1D	41.30		POA	28.969	20.693	16.554	12.416
	16263	2.44	1.5D	61.90		POA	32.073	22.909	18.327	13.751
	16264	3.25	2D	82.60		POA	41.384	29.560	23.648	17.733
1 3/4 - 8	16282	1.75	1D	44.50		POA	28.969	20.693	16.554	12.416
	16283	2.63	1.5D	66.70		POA	36.211	25.864	20.693	15.523
	16284	3.50	2D	88.90		POA	45.523	32.517	26.012	19.505
1 7/8 - 8	16302	1.88	1D	47.60		POA	33.108	23.648	18.918	14.188
	16303	2.81	1.5D	71.40		POA	41.384	29.560	23.648	17.733
	16304	3.75	2D	95.30		POA	51.731	36.950	29.560	22.174
2" - 8	16322	2.00	1D	50.80		POA	35.177	25.126	20.100	15.075
	16323	3.00	1.5D	76.20		POA	45.523	32.517	26.012	19.505
	16324	4.00	2D	101.60		POA	57.938	41.384	33.108	24.832

Australian Price List Effective May 2013

Note! All prices are exclusive of GST

POA - Price On Application - denotes non-popular parts.

Minimum quantities and order values may apply.

Only supplied in full bag quantities.

Dry film lubing and plating available.

Inserts - Stripfeed - Metric



METRIC									
FREE RUNNING		Insert Length				NETT EACH PER INSERT (PACKED ON REELS)			
Thread Size	Part No.	inches	Dia	mm	Qty/Reel	POA	100+	500+	1000+
M2.2 x 0.45	05012SF	0.087	1D	2.2	1000				0.365
	05013SF	0.130	1.5D	3.3	1000				0.392
	05014SF	0.173	2D	4.4	1000				0.404
M2.5 x 0.45	05252SF	0.098	1D	2.5	1000				0.330
	05253SF	0.150	1.5D	3.8	1000				0.351
	05254SF	0.197	2D	5.0	1000				0.370
M3 x 0.5	05032SF	0.118	1D	3.0	1000				0.330
	05033SF	0.177	1.5D	4.5	1000				0.351
	05034SF	0.236	2D	6.0	1000				0.370
M4 x 0.7	05042SF	0.157	1D	4.0	1000				0.330
	05043SF	0.236	1.5D	6.0	1000				0.351
	05044SF	0.315	2D	8.0	1000				0.370
M5 x 0.8	05052SF	0.197	1D	5.0	1000				0.330
	05053SF	0.295	1.5D	7.5	500			0.440	
	05054SF	0.394	2D	10.0	500			0.464	
M6 x 1	05062SF	0.236	1D	6.0	500			0.451	
	05063SF	0.354	1.5D	9.0	500			0.498	
	05064SF	0.472	2D	12.0	500			0.524	
M8 x 1.25	05082SF	0.315	1D	8.0	500		0.670		
	05083SF	0.472	1.5D	12.0	500		0.760		
	05084SF	0.630	2D	16.0	500		0.836		
M8 x 1	07082SF	0.315	1D	8.0	500	POA	0.760		
	07083SF	0.472	1.5D	12.0	500	POA	0.670		
	07084SF	0.630	2D	16.0	500	POA	0.836		
M10 x 1.5	05102SF	0.394	1D	10.0	250		0.945		
	05103SF	0.591	1.5D	15.0	250		1.068		
	05104SF	0.787	2D	20.0	250	POA	1.217		
M12 x 1.75	05122SF	0.472	1D	12.0	125	POA	1.378		
	05123SF	0.709	1.5D	18.0	125	POA	1.490		
	05124SF	0.945	2D	24.0	125	POA	1.739		

SCREW LOCKING									
		Insert Length				NETT EACH PER INSERT (PACKED ON REELS)			
Thread Size	Part No.	inches	Dia	mm	Qty/Reel	POA	100+	500+	1000+
M2.2 x 0.45	15012SF	0.087	1D	2.2	1000	POA			0.455
	15013SF	0.130	1.5D	3.3	1000	POA			0.489
	15014SF	0.173	2D	4.4	1000	POA			0.505
M2.5 x 0.45	15252SF	0.098	1D	2.5	1000	POA			0.413
	15253SF	0.150	1.5D	3.8	1000	POA			0.440
	15254SF	0.197	2D	5.0	1000	POA			0.463
M3.5 x 0.6	15352SF	0.138	1D	3.5	1000	POA			0.439
	15353SF	0.209	1.5D	5.3	1000	POA			0.471
	15354SF	0.276	2D	7.0	1000	POA			0.505
M4 x 0.7	15042SF	0.157	1D	4.0	1000				0.413
	15043SF	0.236	1.5D	6.0	1000				0.440
	15044SF	0.315	2D	8.0	1000				0.463
M5 x 0.8	15052SF	0.197	1D	5.0	1000				0.413
	15053SF	0.295	1.5D	7.5	500			0.440	
	15054SF	0.394	2D	10.0	500			0.463	
M6 x 1	15062SF	0.236	1D	6.0	500			0.451	
	15063SF	0.354	1.5D	9.0	500			0.497	
	15064SF	0.472	2D	12.0	500			0.523	
M8 x 1.25	15082SF	0.315	1D	8.0	500		0.838		
	15083SF	0.472	1.5D	12.0	500		0.951		
	15084SF	0.630	2D	16.0	500		1.047		
M10 x 1.5	15102SF	0.472	1D	12.0	125	POA	1.178		
	15103SF	0.709	1.5D	18.0	125	POA	1.334		
	15104SF	0.945	2D	24.0	125	POA	1.522		
M12 x 1.75	15122SF	0.472	1D	12.0	125	POA	1.723		
	15123SF	0.709	1.5D	18.0	125	POA	1.862		
	15124SF	0.945	2D	24.0	125	POA	2.172		

Inserts - Stripfeed - Inch



UNC FREE RUNNING					UNF FREE RUNNING						
Thread Size	Part No.	Insert Length			Thread Size	Part No.	NETT EACH PER INSERT (PACKED ON REELS)				
		inches	Dia	mm			Qty/Reel	POA	100+	500+	1000+
#2 - 56	03522SF	0.086	1D	2.2			1000				0.425
	03523SF	0.129	1.5D	3.3			1000				0.461
	03524SF	0.172	2D	4.4			1000	POA			0.483
#3 - 48	03532SF	0.099	1D	2.5			1000	POA			0.709
	03533SF	0.149	1.5D	3.8			1000	POA			0.766
	03534SF	0.198	2D	5			1000	POA			0.809
		0.099	1D	2.5	#3 - 56	04532SF	1000	POA			0.709
		0.149	1.5D	3.8		04533SF	1000	POA			0.766
		0.198	2D	5		04534SF	1000	POA			0.809
#4 - 40	03542SF	0.112	1D	2.8			1000				0.326
	03543SF	0.168	1.5D	4.3			1000				0.347
	03544SF	0.224	2D	5.7			1000				0.369
		0.112	1D	2.8	#4 - 48	04542SF	1000	POA			0.326
		0.168	1.5D	4.3		04543SF	1000	POA			0.347
		0.224	2D	5.7		04544SF	1000	POA			0.369
#5 - 40	03552SF	0.125	1D	3.2			1000				0.326
	03553SF	0.188	1.5D	4.8			1000				0.347
	03554SF	0.250	2D	6.4			1000				0.369
#6 - 32	03562SF	0.138	1D	3.5			1000				0.326
	03563SF	0.207	1.5D	5.3			1000				0.347
	03564SF	0.276	2D	7			1000				0.369
		0.138	1D	3.5	#6 - 40	04562SF	1000	POA			0.326
		0.207	1.5D	5.3		04563SF	1000	POA			0.347
		0.276	2D	7		04564SF	1000	POA			0.369
#8 - 32	03582SF	0.164	1D	4.2			1000				0.326
	03583SF	0.246	1.5D	6.2			1000				0.347
	03584SF	0.328	2D	8.3			1000				0.369
		0.164	1D	4.2	#8 - 36	04582SF	1000	POA			0.326
		0.246	1.5D	6.2		04583SF	1000	POA			0.347
		0.328	2D	8.3		04584SF	1000	PAO			0.369
#10 - 24	03602SF	0.190	1D	4.8			1000				0.326
	03603SF	0.285	1.5D	7.2			500			0.435	
	03604SF	0.380	2D	9.7			500			0.461	
		0.190	1D	4.8	#10 - 32	04602SF	1000				0.326
		0.285	1.5D	7.2		04603SF	500			0.435	
		0.380	2D	9.7		04604SF	500			0.461	
1/4 - 20	03042SF	0.250	1D	6.4			500			0.470	
	03043SF	0.375	1.5D	9.5			500			0.488	
	03044SF	0.500	2D	12.7			500			0.550	
		0.250	1D	6.4	1/4 - 28	04042SF	500			0.470	
		0.375	1.5D	9.5		04043SF	500			0.488	
		0.500	2D	12.7		04044SF	500	POA		0.550	
5/16 - 18	03052SF	0.312	1D	7.9			250		0.721		
	03053SF	0.468	1.5D	11.9			250		0.757		
	03054SF	0.624	2D	15.8			250	POA	0.833		
		0.312	1D	7.9	5/16 - 24	04052SF	250	POA	0.721		
		0.468	1.5D	11.9		04053SF	250		0.757		
		0.624	2D	15.8		04054SF	250	POA	0.833		
3/8 - 16	03062SF	0.375	1D	9.5			250	POA	0.970		
	03063SF	0.563	1.5D	14.3			250	POA	1.068		
	03064SF	0.750	2D	19.1			250	POA	1.241		

Australian Price List Effective May 2013
 Note! All prices are exclusive of GST
 POA - Price On Application - denotes non-popular parts.

Minimum quantities and order values may apply.
 Only supplied in full bag quantities.
 Dry film lubing and plating available.

Inserts - Stripfeed - Inch



UNC SCREW LOCKING					UNF SCREW LOCKING						
Thread Size	Part No.	Insert Length			Thread Size	Part No.	NETT EACH PER INSERT (PACKED ON REELS)				
		inches	Dia	mm			Qty/Reel	POA	100+	500+	1000+
#2 - 56	13522SF	0.086	1D	2.2			1000				0.532
	13523SF	0.129	1.5D	3.3			1000				0.575
	13524SF	0.172	2D	4.4			1000				0.603
#3 - 48	13532SF	0.099	1D	2.5			1000				0.886
	13533SF	0.149	1.5D	3.8			1000				0.957
	13534SF	0.198	2D	5			1000				1.011
		0.099	1D	2.5	#3 - 56	14532SF	1000	POA			0.886
		0.149	1.5D	3.8		14533SF	1000	POA			0.957
		0.198	2D	5		14534SF	1000	POA			1.011
#4 - 40	13542SF	0.112	1D	2.8			1000				0.408
	13543SF	0.168	1.5D	4.3			1000				0.434
	13544SF	0.224	2D	5.7			1000				0.462
		0.112	1D	2.8	#4 - 48	14542SF	1000	POA			0.408
		0.168	1.5D	4.3		14543SF	1000	POA			0.434
		0.224	2D	5.7		14544SF	1000	POA			0.462
#5 - 40	13552SF	0.125	1D	3.2			1000				0.408
	13553SF	0.188	1.5D	4.8			1000				0.434
	13554SF	0.250	2D	6.4			1000				0.462
#6 - 32	13562SF	0.138	1D	3.5			1000				0.408
	13563SF	0.207	1.5D	5.3			1000				0.434
	13564SF	0.276	2D	7			1000				0.462
		0.138	1D	3.5	#6 - 40	14562SF	1000	POA			0.408
		0.207	1.5D	5.3		14563SF	1000	POA			0.434
		0.276	2D	7		14564SF	1000	POA			0.462
#8 - 32	13582SF	0.164	1D	4.2			1000				0.408
	13583SF	0.246	1.5D	6.2			1000				0.434
	13584SF	0.328	2D	8.3			1000				0.462
		0.164	1D	4.2	#8 - 36	14582SF	1000	POA			0.408
		0.246	1.5D	6.2		14583SF	1000	POA			0.434
		0.328	2D	8.3		14584SF	1000	POA			0.462
#10 - 24	13602SF	0.190	1D	4.8			1000	POA			0.408
	13603SF	0.285	1.5D	7.2			500	POA		0.545	
	13604SF	0.380	2D	9.7			500	POA		0.575	
		0.190	1D	4.8	#10 - 32	14602SF	1000				0.408
		0.285	1.5D	7.2		14603SF	500			0.545	
		0.380	2D	9.7		14604SF	500			0.575	
1/4 - 20	13042SF	0.250	1D	6.4			500				0.589
	13043SF	0.375	1.5D	9.5			500				0.610
	13044SF	0.500	2D	12.7			500				0.688
		0.250	1D	6.4	1/4 - 28	14042SF	500				0.589
		0.375	1.5D	9.5		14043SF	500				0.610
		0.500	2D	12.7		14044SF	500	POA			0.688
5/16 - 18	13052SF	0.375	1D	9.5			250	POA	0.901		
	13053SF	0.563	1.5D	14.3			250	POA	0.948		
	13054SF	0.750	2D	19.1			250	POA	1.040		
		0.375	1D	9.5	5/16 - 24	14052SF	250	POA	0.901		
		0.563	1.5D	14.3		14053SF	250	POA	0.948		
		0.750	2D	19.1		14054SF	250	POA	1.040		
3/8 - 16	13062SF	0.312	1D	7.9			250	POA	1.211		
	13063SF	0.468	1.5D	11.9			250	POA	1.334		
	13064SF	0.624	2D	15.8			250	POA	1.552		

Australian Price List Effective May 2013
 Note! All prices are exclusive of GST
 POA - Price On Application - denotes non-popular parts.

Minimum quantities and order values may apply.
 Only supplied in full bag quantities.
 Dry film lubing and plating available.

Taps - Straight Flute Taps (Hand/Short Machine)

Metric - ISO Dimensions, HSS Material - 4H5H Tolerance



METRIC COARSE					METRIC MEDIUM					METRIC FINE					
Thread Size	Part No.	POA	TYPE	PRICE	Thread Size	Part No.	POA	TYPE	PRICE	Thread Size	Part No.	POA	TYPE	PRICE	
M2 x 0.4	45024		TAPER	58.901											
	45025		INTER	58.901											
	45026		BOTT	58.901											
M2.2 x 0.45	45014	POA	TAPER	58.901											
	45015		INTER	58.901											
	45016		BOTT	58.901											
M2.5 x 0.45	45254		TAPER	42.951											
	45255		INTER	42.951											
	45256		BOTT	42.951											
M3 x 0.5	45034		TAPER	36.811											
	45035		INTER	36.811											
	45036		BOTT	36.811											
M3.5 x 0.6	45354		TAPER	42.951											
	45355		INTER	42.951											
	45356		BOTT	42.951											
M4 x 0.7	45044		TAPER	34.361											
	45045		INTER	34.361											
	45046		BOTT	34.361											
M5 x 0.8	45054		TAPER	34.361											
	45055		INTER	34.361											
	45056		BOTT	34.361											
M6 x 1	45064		TAPER	34.361											
	45065		INTER	34.361											
	45066		BOTT	34.361											
	45067		P/ NOSE	49.081											
	45065LH		L/ HAND	98.162											
M7 x 1	45074		TAPER	42.951											
	45075		INTER	42.951											
	45076		BOTT	42.951											
M8 x 1.25	45084		TAPER	40.491	M8 x 1	47084		TAPER	42.951	M8 x 0.75	48084	POA	TAPER	51.531	
	45085		INTER	40.491		47085		INTER	42.951		48085	POA	INTER	51.531	
	45086		BOTT	40.491		47086		BOTT	42.951		48086	POA	BOTT	51.531	
	45087		P/ NOSE	61.351											
	45085LH		L/ HAND	110.432											
M9 x 1.25	45094		TAPER	61.351	M9 x 1	47094	POA	TAPER	61.351						
	45095		INTER	61.351		47095		INTER	61.351						
	45096	POA	BOTT	61.351		47096		BOTT	61.351						
M10 x 1.5	45104		TAPER	49.081	M10 x 1.25	47104		TAPER	49.081	M10 x 1	48104		TAPER	55.221	
	45105		INTER	49.081		47105		INTER	49.081		48105		INTER	55.221	
	45106		BOTT	49.081		47106		BOTT	49.081		48106		BOTT	55.221	
	45107		P/ NOSE	67.491		47107		P/ NOSE	67.491		48107		P/ NOSE	79.762	
	45105LH		L/ HAND	122.702											
M11 x 1.5	45114		TAPER	67.491	M11 x 1.25	47114		TAPER	67.491	M11 x 1	48114		TAPER	67.491	
	45115		INTER	67.491		47115		INTER	67.491		48115		INTER	67.491	
	45116		BOTT	67.491		47116		BOTT	67.491		48116		BOTT	67.491	

Australian Price List Effective May 2013

Note! All prices are exclusive of GST

POA - Price On Application - denotes non-popular parts.

Minimum quantities and order values may apply.

Taps - Straight Flute Taps (Hand/Short Machine)

Metric - ISO Dimensions, HSS Material - 4H5H Tolerance



METRIC COARSE					METRIC MEDIUM					METRIC FINE					
Thread Size	Part No.	POA	TYPE	PRICE	Thread Size	Part No.	POA	TYPE	PRICE	Thread Size	Part No.	POA	TYPE	PRICE	
M12 x 1.75	45124		TAPER	67.491	M12 x 1.5	47124		TAPER	67.491	M12 x 1.25	48124		TAPER	73.621	
	45125		INTER	67.491		47125		INTER	67.491		48125		INTER	73.621	
	45126		BOTT	67.491		47126		BOTT	67.491		48126		BOTT	73.621	
	45127		P/NOSE	79.762							48127		P/NOSE	85.892	
	45125LH		L/HAND	134.972											
										M12 x 1	48124-1		TAPER	116.572	
											48125-1		INTER	116.572	
											48126-1		BOTT	116.572	
M13 x 1.75	45135		INTER	79.762	M13 x 1.5	47135		INTER	79.762	M13 x 1.25	48135		INTER	79.762	
M14 x 2	45144		TAPER	79.762	M14 x 1.5	47144		TAPER	79.762	M14 x 1.25	48144		TAPER	83.442	
	45145		INTER	79.762		47145		INTER	79.762		48145		INTER	83.442	
	45146		BOTT	79.762		47146		BOTT	79.762		48146		BOTT	83.442	
											48147		P/NOSE	95.712	
M15 x 2	45154	POA	TAPER	98.162	M15 x 1.5	47154	POA	TAPER	98.162						
	45155		INTER	98.162		47155		INTER	98.162						
	45156		BOTT	98.162		47156		BOTT	98.162						
M16 x 2	45164		TAPER	92.032	M16 x 1.5	47164		TAPER	98.162						
	45165		INTER	92.032		47165		INTER	98.162						
	45166		BOTT	92.032		47166		BOTT	98.162						
M18 x 2.5	45184		TAPER	147.243	M18 x 2	47184		TAPER	159.513	M18 x 1.5	48184		TAPER	147.243	
	45185		INTER	147.243		47185		INTER	159.513		48185		INTER	147.243	
	45186		BOTT	147.243		47186		BOTT	159.513		48186		BOTT	147.243	
									48187			P/NOSE	184.053		
M20 x 2.5	45204		TAPER	159.513	M20 x 2	47204		TAPER	171.783	M20 x 1.5	48204		TAPER	165.653	
	45205		INTER	159.513		47205		INTER	171.783		48205		INTER	165.653	
	45206		BOTT	159.513		47206		BOTT	171.783		48206		BOTT	165.653	
M22 x 2.5	45224		TAPER	184.053	M22 x 2	47224	POA	TAPER	196.324	M22 x 1.5	48224		TAPER	184.053	
	45225		INTER	184.053		47225		INTER	196.324		48225		INTER	184.053	
	45226		BOTT	184.053		47226		BOTT	196.324		48226		BOTT	184.053	
M24 x 3	45244		TAPER	220.864	M24 x 2	47244		TAPER	233.134	M24 x 1.5	48244		TAPER	220.864	
	45245		INTER	220.864		47245		INTER	233.134		48245		INTER	220.864	
	45246		BOTT	220.864		47246		BOTT	233.134		48246		BOTT	220.864	
											M26 x 1.5	48264		TAPER	306.756
											48265		INTER	306.756	
											48266		BOTT	306.756	
M27 x 3	45274		TAPER	323.488	M27 x 2	47274		TAPER	345.797	M27 x 1.5	48274		TAPER	380.377	
	45275		INTER	323.488		47275		INTER	345.797		48275		INTER	380.377	
	45276		BOTT	323.488		47276	POA	BOTT	345.797		48276	POA	BOTT	380.377	
M30 x 3.5	45304		TAPER	334.643	M30 x 2	47304		TAPER	356.952	M30 x 1.5	48304		TAPER	392.647	
	45305		INTER	334.643		47305		INTER	356.952		48305		INTER	392.647	
	45306		BOTT	334.643		47306		BOTT	356.952		48306		BOTT	392.647	
M30 x 3	45305-3		INTER	368.107											
M33 x 3.5	45334		TAPER	390.416	M33 x 2	47335		TAPER	390.416						
	45335		INTER	390.416		47335		INTER	390.416						
	45336		BOTT	390.416		47336		BOTT	390.416						
M36 x 4	45364		TAPER	457.345	M36 x 3	47364		TAPER	557.738	M36 x 1.5	48364	POA	TAPER	552.160	
	45365		INTER	457.345		47365		INTER	557.738		48365		INTER	552.160	
	45366		BOTT	457.345		47366		BOTT	557.738		48366	POA	BOTT	552.160	
M39 x 4	45394		TAPER	613.511	M39 x 3	47394	POA	TAPER	669.285	M39 x 2	48394		TAPER	674.862	
	45395		INTER	613.511		47395		INTER	669.285		48395		INTER	674.862	
	45396		BOTT	613.511		47396		BOTT	669.285		48396		BOTT	674.862	
M42 x 4.5	45424		TAPER	780.833	M42 x 3	47424	POA	TAPER	780.833	M42 x 2	48424	POA	TAPER	858.916	
	45425	POA	INTER	780.833		47425	POA	INTER	780.833		48425	POA	INTER	858.916	
	45426		BOTT	780.833		47426		BOTT	780.833		48426		BOTT	858.916	
M42 x 4	45425-4		INTER	780.833											

Taps - Straight Flute & Spiral Point Taps (Machine)

Metric - ISO Dimensions, HSS Material - Spiral Flute & Spiral Point - 4H5H Tolerance



METRIC COARSE					METRIC MEDIUM				
Thread Size	Part No.	POA	TYPE	PRICE	Thread Size	Part No.	POA	TYPE	PRICE
M2 x 0.4	45028		SP/POINT	74.852					
	45029		SP/FLUTE	74.852					
M2.2 x 0.45	45018		SP/POINT	74.852					
	45019		SP/FLUTE	74.852					
M2.5 x 0.45	45258		SP/POINT	49.081					
	45259		SP/FLUTE	49.081					
M3 x 0.5	45038		SP/POINT	49.081					
	45039		SP/FLUTE	49.081					
M3.5 x 0.6	45358		SP/POINT	42.951					
	45359		SP/FLUTE	42.951					
M4 x 0.7	45048		SP/POINT	42.951					
	45049		SP/FLUTE	42.951					
	45058		SP/POINT	42.951					
M5 x 0.8	45059		SP/FLUTE	42.951					
M6 x 1	45068		SP/POINT	46.631					
	45069		SP/FLUTE	46.631					
M8 x 1.25	45088		SP/POINT	50.311	M8 x 1	47088		SP/POINT	49.081
	45089		SP/FLUTE	50.311		47089		SP/FLUTE	49.081
M10 x 1.5	45108		SP/POINT	55.221	M10 x 1.25	47108		SP/POINT	61.351
	45109		SP/FLUTE	55.221		47109		SP/FLUTE	61.351
M12 x 1.75	45128		SP/POINT	79.762	M12 x 1.5	47128		SP/POINT	85.892
	45129		SP/FLUTE	79.762		47129		SP/FLUTE	85.892
M14 x 2	45148		SP/POINT	98.162	M14 x 1.5	47148		SP/POINT	110.432
	45149		SP/FLUTE	98.162		47149		SP/FLUTE	110.432
M16 x 2	45168		SP/POINT	110.432	M16 x 1.5	47168		SP/POINT	122.702
	45169		SP/FLUTE	110.432		47169		SP/FLUTE	122.702
M18 x 2.5	45188		SP/POINT	220.864					
	45189		SP/FLUTE	220.864					
M20 x 2.5	45208		SP/POINT	196.324					
	45209		SP/FLUTE	196.324					
M24 x 3	45248		SP/POINT	233.134					
	45249		SP/FLUTE	233.134					

Australian Price List Effective May 2013

Note! All prices are exclusive of GST

POA - Price On Application - denotes non-popular parts.

Minimum quantities and order values may apply.

Taps - Straight Flute Taps (Hand/Short Machine)

Inch- ISO British Dimensions, ANSI / BS Dimensions, Other Sizes HSS Material - 3B Tolerance



UNC					BSW					UNF					
Thread Size	Part No.	POA	TYPE	PRICE	Thread Size	Part No.	POA	TYPE	PRICE	Thread Size	Part No.	POA	TYPE	PRICE	
#2 - 56	43524		TAPER	39.219	1/8 - 40	42024	POA	TAPER	61.351						
	43525		INTER	39.219		42025		INTER	61.351						
	43526		BOTT	39.219		42026	POA	BOTT	61.351						
#3 - 48	43534	POA	TAPER	61.351						#3 - 56	44534	POA	TAPER	61.351	
	43535		INTER	61.351							44535		INTER	61.351	
	43536	POA	BOTT	61.351							44536	POA	BOTT	61.351	
#4 - 40	43544		TAPER	39.261						#4 - 48	44544	POA	TAPER	61.351	
	43545		INTER	39.261							44545		INTER	61.351	
	43546		BOTT	39.261							44546	POA	BOTT	61.351	
#5 - 40	43554		TAPER	42.951											
	43555		INTER	42.951											
	43556		BOTT	42.951											
#6 - 32	43564		TAPER	34.361						#6 - 40	44564	POA	TAPER	61.351	
	43565		INTER	34.361							44565		INTER	61.351	
	43566		BOTT	34.361							44566	POA	BOTT	61.351	
#8 - 32	43584		TAPER	36.811						#8 - 36	44584	POA	TAPER	61.351	
	43585		INTER	36.811							44585		INTER	61.351	
	43586		BOTT	36.811							44586	POA	BOTT	61.351	
#10 - 24	43604		TAPER	36.811						#10 - 32	44604		TAPER	36.811	
	43605		INTER	36.811							44605		INTER	36.811	
	43606		BOTT	36.811							44606		BOTT	36.811	
#12 - 24	43624		TAPER	39.261	3/16 - 24	42034		TAPER	42.946						
	43625		INTER	39.261		42035		INTER	42.946		#12 - 28	44624	POA	TAPER	42.951
	43626		BOTT	39.261		42036		BOTT	42.946			44625		INTER	42.951
1/4 - 20	43044		TAPER	36.811	1/4 - 20	42044		TAPER	40.492						
	43045		INTER	36.811		42045		INTER	40.492		44044		TAPER	36.811	
	43046		BOTT	36.811		42046		BOTT	40.492		44045		INTER	36.811	
5/16 - 18	43054		TAPER	40.491	5/16 - 18	42054		TAPER	42.946		5/16 - 24	44054		TAPER	40.491
	43055		INTER	40.491		42055		INTER	42.946			44055		INTER	40.491
	43056		BOTT	40.491		42056		BOTT	42.946			44056		BOTT	40.491
3/8 - 16	43064		TAPER	44.171	3/8 - 16	42064		TAPER	49.081		3/8 - 24	44064		TAPER	44.171
	43065		INTER	44.171		42065		INTER	49.081			44065		INTER	44.171
	43066		BOTT	44.171		42066		BOTT	49.081			44066		BOTT	44.171
7/16 - 14	43074		TAPER	58.901	7/16 - 14	42074		TAPER	63.805		7/16 - 20	44074		TAPER	58.901
	43075		INTER	58.901		42075		INTER	63.805			44075		INTER	58.901
	43076		BOTT	58.901		42076		BOTT	63.805			44076		BOTT	58.901
1/2 - 13	43084		TAPER	66.261	1/2 - 12	42084		TAPER	71.167		1/2 - 20	44084		TAPER	66.261
	43085		INTER	66.261		42085		INTER	71.167			44085		INTER	66.261
	43086		BOTT	66.261		42086		BOTT	71.167			44086		BOTT	66.261
9/16 - 12	43094		TAPER	79.762	9/16 - 12	42094	POA	TAPER	92.027		9/16 - 18	44094		TAPER	79.762
	43095		INTER	79.762		42095		INTER	92.027			44095		INTER	79.762
	43096		BOTT	79.762		42096	POA	BOTT	92.027			44096		BOTT	79.762
5/8 - 11	43104		TAPER	92.032	5/8 - 11	42104	POA	TAPER	104.297		5/8 - 18	44104		TAPER	92.032
	43105		INTER	92.032		42105		INTER	104.297			44105		INTER	92.032
	43106		BOTT	92.032		42106	POA	BOTT	104.297			44106		BOTT	92.032
11/16 - 11	43114	POA	TAPER	202.464											
	43115		INTER	194.21											
	43116	POA	BOTT	194.21											
3/4 - 10	43124		TAPER	135.36	3/4 - 10	42124	POA	TAPER	147.13		3/4 - 16	44124		TAPER	135.36
	43125		INTER	135.36		42125		INTER	147.13			44125		INTER	135.36
	43126		BOTT	135.36		42126	POA	BOTT	147.13			44126		BOTT	135.36
7/8 - 9	43144		TAPER	170.67	7/8 - 9	42144	POA	TAPER	182.44		7/8 - 14	44144	POA	TAPER	170.67
	43145		INTER	170.67		42145		INTER	182.44			44145		INTER	170.67
	43146		BOTT	170.67		42146	POA	BOTT	182.44			44146	POA	BOTT	170.67

Australian Price List Effective May 2013

Note! All prices are exclusive of GST

POA - Price On Application - denotes non-popular parts.

Minimum quantities and order values may apply.

Taps - Straight Flute Taps (Hand/Short Machine)

Inch - ISO British Dimensions, ANSI / BS Dimensions, Other Sizes HSS Material - 3B Tolerance



UNC					BSW					UNF				
Thread Size	Part No.	POA	TYPE	PRICE	Thread Size	Part No.	POA	TYPE	PRICE	Thread Size	Part No.	POA	TYPE	PRICE
1" - 8	43164		TAPER	211.86	1" - 8	42164	POA	TAPER	235.40	1" - 12	44164	POA	TAPER	211.86
	43165		INTER	211.86		42165		INTER	235.40		44165		INTER	211.86
	43166		BOTT	211.86		42166	POA	BOTT	235.40		44166	POA	BOTT	211.86
1 1/8 - 7	43184		TAPER	294.25	1 1/8 - 7	42184	POA	TAPER	317.79	1 1/8 - 12	44184	POA	TAPER	294.25
	43185		INTER	294.25		42185		INTER	317.79		44185		INTER	294.25
	43186		BOTT	294.25		42186	POA	BOTT	317.79		44186	POA	BOTT	294.25
1 1/4 - 7	43204		TAPER	353.10	1 1/4 - 7	42204	POA	TAPER	388.41	1 1/4 - 12	44204	POA	TAPER	353.10
	43205		INTER	353.10		42205		INTER	388.41		44205		INTER	353.10
	43206		BOTT	353.10		42206	POA	BOTT	388.41		44206	POA	BOTT	353.10
1 3/8 - 6	43224		TAPER	388.41	1 3/8 - 6	42224	POA	TAPER	411.95	1 3/8 - 12	44224	POA	TAPER	411.95
	43225		INTER	388.41		42225		INTER	411.95		44225		INTER	411.95
	43226		BOTT	388.41		42226	POA	BOTT	411.95		44226	POA	BOTT	411.95
1 1/2 - 6	43244		TAPER	506.11	1 1/2 - 6	42244	POA	TAPER	529.65	1 1/2 - 12	44244	POA	TAPER	506.11
	43245		INTER	506.11		42245		INTER	529.65		44245		INTER	506.11
	43246		BOTT	506.11		42246	POA	BOTT	529.65		44246	POA	BOTT	506.11

UNC					UNF				
Thread Size	Part No.	POA	TYPE	PRICE	Thread Size	Part No.	POA	TYPE	PRICE
#2 - 56	43528	POA	SP/POINT	46.631					
	43529		SP/FLUTE	46.631					
#3 - 48	43538	POA	SP/POINT	73.621					
	43539		SP/FLUTE	73.621					
#4 - 40	43548	POA	SP/POINT	46.631	#4 - 48	44548	POA	SP/POINT	73.621
	43549		SP/FLUTE	46.631		44549	POA	SP/FLUTE	73.621
#5 - 40	43558	POA	SP/POINT	49.081					
	43559		SP/FLUTE	49.081					
#6 - 32	43568	POA	SP/POINT	42.951	#6 - 40	44568	POA	SP/POINT	73.621
	43569		SP/FLUTE	42.951		44569	POA	SP/FLUTE	73.621
#8 - 32	43588	POA	SP/POINT	42.951	#8 - 36	44588	POA	SP/POINT	73.621
	43589		SP/FLUTE	42.951		44589	POA	SP/FLUTE	73.621
#10 - 24	43608	POA	SP/POINT	42.951	#10 - 32	44608	POA	SP/POINT	42.951
	43609		SP/FLUTE	42.951		44609		SP/FLUTE	42.951
#12 - 24	43628	POA	SP/POINT	49.081					
	43629		SP/FLUTE	49.081					
1/4 - 20	43048	POA	SP/POINT	46.631	1/4 - 28	44048	POA	SP/POINT	46.631
	43049		SP/FLUTE	46.631		44049		SP/FLUTE	46.631
5/16 - 18	43058	POA	SP/POINT	49.081	5/16 - 24	44058	POA	SP/POINT	49.081
	43059		SP/FLUTE	49.081		44059		SP/FLUTE	49.081
3/8 - 16	43068	POA	SP/POINT	55.221	3/8 - 24	44068	POA	SP/POINT	55.221
	43069		SP/FLUTE	55.221		44069		SP/FLUTE	55.221
7/16 - 14	43078	POA	SP/POINT	73.621	7/16 - 20	44078	POA	SP/POINT	73.621
	43079		SP/FLUTE	73.621		44079		SP/FLUTE	73.621
1/2 - 13	43088	POA	SP/POINT	82.212	1/2 - 20	44088	POA	SP/POINT	82.212
	43089		SP/FLUTE	82.212		44089		SP/FLUTE	82.212
5/8 - 11	43108	POA	SP/POINT	110.432	5/8 - 18	44108	POA	SP/POINT	110.432
	43109		SP/FLUTE	110.432		44109		SP/FLUTE	110.432
3/4 - 10	43128	POA	SP/POINT	177.923	3/4 - 16	44128	POA	SP/POINT	177.923
	43129		SP/FLUTE	177.923		44129		SP/FLUTE	177.923
7/8 - 9	43148	POA	SP/POINT	220.864					
	43149		SP/FLUTE	220.864					
1" - 8	43168	POA	SP/POINT	306.756					
	43169		SP/FLUTE	306.756					

Australian Price List Effective May 2013
 Note! All prices are exclusive of GST
 POA - Price On Application - denotes non-popular parts.
 Minimum quantities and order values may apply.

Taps - Straight Flute Taps (Hand/Short Machine)

Inch - ISO British Sizes, ANSI / BS Dimensions, BA Dimensions, other sizes, HSS Material - 3B Tolerance



BSF				
Thread Size	Part No.	POA	TYPE	PRICE
3/16 - 32	40034	POA	TAPER	55.216
	40035		INTER	55.216
	40036		BOTT	55.216
1/4 - 26	40044	POA	TAPER	55.216
	40045		INTER	55.216
	40046		BOTT	55.216
5/16 - 22	40054	POA	TAPER	58.897
	40055		INTER	58.897
	40056	POA	BOTT	58.897
3/8 - 20	40064	POA	TAPER	67.486
	40065		INTER	67.486
	40066	POA	BOTT	67.486
7/16 - 18	40074	POA	TAPER	92.027
	40075		INTER	92.027
	40076	POA	BOTT	92.027
1/2 - 16	40084	POA	TAPER	98.162
	40085		INTER	98.162
	40086	POA	BOTT	98.162
9/16 - 16	40094	POA	TAPER	110.432
	40095		INTER	110.432
	40096	POA	BOTT	110.432
5/8 - 14	40104	POA	TAPER	134.972
	40105		INTER	134.972
	40106	POA	BOTT	134.972
3/4 - 12	40124	POA	TAPER	203.777
	40125	POA	INTER	203.777
	40126	POA	BOTT	203.777
7/8 - 11	40144	POA	TAPER	226.999
	40145		INTER	226.999
	40146	POA	BOTT	226.999
1" - 10	40164	POA	TAPER	312.891
	40165		INTER	312.891
	40166	POA	BOTT	312.891
1 1/4 - 9	40204	POA	TAPER	441.728
	40205		INTER	441.728
	40206	POA	BOTT	441.728

BA				
Thread Size	Part No.	POA	TYPE	PRICE
0 BA	40504		TAPER	73.621
	40505		INTER	73.621
	40506		BOTT	73.621
2 BA	40524		TAPER	73.621
	40525		INTER	73.621
	40526		BOTT	73.621
4 BA	40544		TAPER	73.621
	40545		INTER	73.621
	40546		BOTT	73.621
6 BA	40564		TAPER	73.621
	40565		INTER	73.621
	40566		BOTT	73.621

BSP				
Thread Size	Part No.	POA	TYPE	PRICE
1/8 - 28	41024	POA	TAPER	85.892
	41025		INTER	85.892
	41026		BOTT	85.892
1/4 - 19	41044		TAPER	116.567
	41045		INTER	116.567
	41046		BOTT	116.567
3/8 - 19	41064		TAPER	153.378
	41065		INTER	153.378
	41066		BOTT	153.378
1/2 - 14	41084		TAPER	233.134
	41085		INTER	233.134
	41086		BOTT	233.134
5/8 - 14	41104		TAPER	269.945
	41105		INTER	269.945
	41106		BOTT	269.945
3/4 - 14	41124		TAPER	294.485
	41125		INTER	294.485
	41126		BOTT	294.485
1" - 11	41164		TAPER	404.917
	41165		INTER	404.917
	41166		BOTT	404.917

SPECIAL SIZES				
Thread Size	Part No.	POA	TYPE	PRICE
UNEF 1/4 - 32	44044-32		TAPER	61.351
	44045-32		INTER	61.351
	44046-32		BOTT	61.351
HARLEY 1/4 - 24	44044-24		TAPER	61.351
	44045-24		INTER	61.351
	44046-24		BOTT	61.351
HARLEY 7/16 - 16	44074-16		TAPER	98.162
	44075-16		INTER	98.162
	44076-16		BOTT	98.162
CARB. 7/8 - 20	44144-20		TAPER	269.945
	44145-20		INTER	269.945
	44146-20		BOTT	269.945
CARB. 1 - 20	44164-20	POA	TAPER	319.026
	44165-20		INTER	319.026
	44166-20		BOTT	319.026
CUMMINS 11/16 - 16	44114-16		TAPER	220.864
	44115-16		INTER	220.864
	44116-16	POA	BOTT	220.864

NPT				
Thread Size	Part No.	POA	TYPE	PRICE
1/8 - 27	46024	POA	TAPER	184.053
	46025		INTER	184.053
	46026		BOTT	184.053
1/4 - 18	46044	POA	TAPER	196.324
	46045		INTER	196.324
	46046		BOTT	196.324
3/8 - 18	46064		TAPER	245.405
	46065		INTER	245.405
	46066		BOTT	245.405
1/2 - 14	46084	POA	TAPER	306.756
	46085		INTER	306.756
	46086		BOTT	306.756
3/4 - 14	46124	POA	TAPER	368.107
	46125		INTER	368.107
	46126		BOTT	368.107
1 - 11 1/2	46164	POA	TAPER	552.160
	46165		INTER	552.160
	46166		BOTT	552.160

BSC				
Thread Size	Part No.	POA	TYPE	PRICE
5/16 - 26	46504		TAPER	61.351
	46505		INTER	61.351
	46506		BOTT	61.351
3/8 - 26	46604		TAPER	73.621
	46605		INTER	73.621
	46606		BOTT	73.621
7/16 - 26	46704	POA	TAPER	92.027
	46705		INTER	92.027
	46706		BOTT	92.027
1/2 - 26	46804	POA	TAPER	110.432
	46805		INTER	110.432
	46806		BOTT	110.432

8 TPI UN				
Thread Size	Part No.	POA	TYPE	PRICE
1 1/8 - 8	46184		TAPER	368.107
	46185		INTER	368.107
	46186	POA	BOTT	368.107
1 1/4 - 8	46204		TAPER	429.458
	46205		INTER	429.458
	46206		BOTT	429.458
1 3/8 - 8	46224		TAPER	552.160
	46225		INTER	552.160
	46226		BOTT	552.160
1 1/2 - 8	46244		TAPER	429.458
	46245		INTER	429.458
	46246		BOTT	429.458

8 TPI UN				
Thread Size	Part No.	POA	TYPE	PRICE
1 5/8 - 8	46264		TAPER	662.592
	46265		INTER	662.592
	46266		BOTT	662.592
1 3/4 - 8	46284		TAPER	736.214
	46285		INTER	736.214
	46286		BOTT	736.214
1 7/8 - 8	46304	POA	TAPER	858.916
	46305		INTER	858.916
	46306		BOTT	858.916
2" - 8	46324		TAPER	920.267
	46325		INTER	920.267
	46326		BOTT	920.267

Australian Price List Effective May 2013
Note! All prices are exclusive of GST

POA - Price On Application - denotes non-popular parts.
Minimum quantities and order values may apply.

Tap Coatings - TiN - Titanium Nitride Coating

TiCN - Titanium Carbonitride Coating, TiAlN - Titanium Aluminium Nitride Coating



TAP SIZES				TiNite	TiCN	TiAlN
INCH		METRIC		Price Nett	Price Nett	Price Nett
#2		M2		3.15	4.71	5.35
#3		M2.5		3.15	4.71	5.35
#4		M3	6BA	3.15	4.71	5.35
#5	1/8"			3.15	4.71	5.35
#6		M3.5	4BA	3.53	5.34	6.01
#8		M4		3.53	5.34	6.01
#10		M5	2BA	3.53	5.34	6.01
#12				3.53	5.34	6.01
	1/4"	M6	OBA	5.65	8.47	9.60
		M7		5.65	8.47	9.60
	5/16"	M8		8.47	12.72	14.41
	3/8"	M9		8.47	12.72	14.41
		M10		8.47	12.72	14.41
	7/16"	M11		8.47	12.72	14.41
		M12		11.30	16.95	19.21
	1/2"	M13		11.30	16.95	19.21
	9/16"	M14		11.30	16.95	19.21
		M15		11.30	16.95	19.21
	5/8"	M16		13.97	20.96	23.75
		M18		13.97	20.96	23.75
	3/4"			22.52	33.81	38.28
	11/16"	M20		22.52	33.81	38.28
	7/8"	M22		22.52	33.81	38.28
		M24		22.52	33.81	38.28
	1"			22.52	33.81	38.28
		M27		28.02	42.05	47.62
	1 1/8"			28.02	42.05	47.62
		M30		28.02	42.05	47.62
	1 1/4"			28.02	42.05	47.62
		M33		28.02	42.05	47.62
	1 3/8"			28.02	42.05	47.62
		M36		56.27	84.43	95.65
	1 1/2"			56.27	84.43	95.65
		M39		73.77	110.64	125.40
	1 5/8"	M42		73.77	110.64	125.43
	1 3/4"	M47		112.99	169.49	192.08
	1 7/8"	M48		112.99	169.49	192.08
	2"	M50		112.99	169.49	192.08

Australian Price List Effective May 2013

Note! All prices are exclusive of GST

POA - Price On Application - denotes non-popular parts.

Minimum quantities and order values may apply.



Taper



Intermediate



Bottoming



Spiral flute



Spiral point

Gauges - For Gauging STI Holes

i.e. the tapped hole before the insert is installed



METRIC COARSE 65000+ TOLERANCE				
Size	4H5H		5H MED	EACH
M2.0 x 0.4	65024	POA	65025	POA
M2.2 x 0.45	65014	POA	65015	POA
M2.5 x 0.45	65254	435.77	65255	435.76
M3 x 0.5	65034	401.36	65035	401.36
M3.5 x 0.6	65354	POA	65355	POA
M4 x 0.7	65044	401.36	65045	401.36
M5 x 0.8	65054	401.363	65055	401.36
M6 x 1	65064	401.36	65065	401.36
M7 x 1	65074	POA	65075	POA
M8 x 1.25	65084	401.36	65085	401.36
M9 x 1.25	65094	POA	65095	POA
M10 x 1.5	65104	470.17	65105	470.16
M11 x 1.5	65114	POA	65115	POA
M12 x 1.75	65124	470.168	65125	470.17
M13 x 1.75	65134	POA	65135	POA
M14 x 2	65144	POA	65145	POA
M15 x 2	65154	POA	65155	POA
M16 x 2	65164	538.97	65165	538.97
M18 x 2.5	65184	POA	65185	POA
M20 x 2.5	65204	POA	65205	POA
M22 x 2.5	65224	POA	65225	POA
M24 x 3	65244	POA	65245	POA
M27 x 3	65274	POA	65275	POA
M30 x 3.5	65304	POA	65305	POA
M30 x 3	65304-3	POA	65305-3	POA
M36 x 4	65364	POA	65365	POA
M39 x 4	65394	POA	65395	POA
M42 x 4.5	65424	POA	65425	POA
M42 x 4	65424-4	POA	65425-4	POA

BSC 66500+ TOLERANCE				
Size			MEDIUM	EACH
1/4 - 26			60042	POA
5/16 - 26			66502	POA
3/8 - 26			66602	POA
7/16 - 26			66702	POA
1/2 - 26			66802	POA

METRIC MEDIUM 67000+ TOLERANCE				
Size	4H5H		5H MED	EACH
M8 x 1	67084	435.76	67085	435.76
M9 x 1	67094	POA	67095	POA
M10 x 1.25	67104	504.57	67105	504.57
M11 x 1.25	67114	POA	67115	POA
M12 x 1.5	67124	504.57	67125	504.57
M13 x 1.5	67134	POA	67135	POA
M14 x 1.5	67144	POA	67145	POA
M15 x 1.5	67154	POA	67155	POA
M16 x 1.5	67164	POA	67165	POA
M18 x 2	67184	POA	67185	POA
M20 x 2	67204	POA	67205	POA
M22 x 2	67224	POA	67225	POA
M24 x 2	67244	POA	67245	POA
		POA		POA
M27 x 2	67274	POA	67305	POA
		POA		POA
M30 x 2	67304	POA	67305	POA
M36 x 3	67364	POA	67365	POA
M39 x 3	67394	POA	67395	POA
M42 x 3	67424	POA	67425	POA

UNC 63000+ TOLERANCE				
Size	3B CLOSE		2B MEDIUM	EACH
#2 - 56	63523	516.04	63522	516.03
#3 - 48	63533	POA	63532	POA
#4 - 40	63543	401.36	63542	401.36
#5 - 40	63553	POA	63552	POA
#6 - 32	63563	401.36	63562	401.36
#8 - 32	63583	401.36	63582	401.36
#10 - 24	63603	401.36	63602	401.36
#12 - 24	63623	POA	63622	POA
1/4 - 20	63043	401.36	63042	401.36
5/16 - 18	63053	401.36	63052	401.36
3/8 - 16	63063	401.36	63062	401.36
7/16 - 14	63073	470.17	63072	470.16
1/2 - 13	63083	470.17	63082	470.16
9/16 - 12	63093	POA	63092	POA
5/8 - 11	63103	POA	63102	POA
11/16 - 11	63113	POA	63112	POA
3/4 - 10	63123	POA	63122	POA
7/8 - 9	63143	POA	63142	POA
1" - 8	63163	POA	63162	POA
1 1/8 - 7	63183	POA	63182	POA
1 1/4 - 7	63203	POA	63202	POA
1 3/8 - 6	63223	POA	63222	POA
1 1/2 - 6	63243	POA	63242	POA

UNF 64000+ TOLERANCE				
Size	3B CLOSE		2B MEDIUM	EACH
#3 - 56	64533	POA	64532	POA
#4 - 48	64543	POA	64542	POA
#6 - 40	64563	POA	64562	POA
#8 - 36	64583	POA	64582	POA
#10 - 32	64603	401.36	64602	POA
1/4 - 28	64043	401.36	64042	401.36
5/16 - 24	64053	401.36	64052	401.36
3/8 - 24	64063	401.36	64062	401.36
7/16 - 20	64073	POA	64072	POA
1/2 - 20	64083	POA	64082	POA
9/16 - 18	64093	POA	64092	POA
5/8 - 18	64103	POA	64102	POA
3/4 - 16	64123	POA	64122	POA
7/8 - 14	64143	POA	64142	POA
1" - 12	64163	POA	64162	POA
1" - 14	64163-14	POA	64162-14	POA
1 1/8 - 12	64183	POA	64182	POA
1 1/4 - 12	64203	POA	64202	POA
1 3/8 - 12	64223	POA	64222	POA
1 1/2 - 12	64243	POA	64242	POA

Gauges - For Gauging STI Holes

i.e. the tapped hole before the insert is installed



BA 60500+ TOLERANCE				
Size	CLOSE		MEDIUM	EACH
0 BA			60502	POA
1 BA			60512	POA
2 BA			60522	POA
4 BA			60542	POA
6 BA			60562	POA

METRIC X-FINE 68000+ TOLERANCE				
Size	4H5H		5H MED	EACH
M10 x 1	68104	POA	68105	POA
M11 x 1	68114	POA	68115	POA
M12 x 1.25	68124	POA	68125	POA
M13 x 1.25	68134	POA	68135	POA
M18 x 1.5*	68184	POA	68185	POA
M20 x 1.5	68204	POA	68205	POA
M22 x 1.5	68224	POA	68225	POA
M24 x 1.5	68244	POA	68245	POA
M26 x 1.5	68264	POA	68265	POA
M27 x 1.5	68274	POA	68275	POA
		POA		POA
M30 x 1.5	68304	POA	68305	POA
M36 x 1.5	68364	POA	68365	POA
M39 x 2	68394	POA	68395	POA
M42 x 2	68424	POA	68425	POA

* Different to sparkplug

SPARKPLUG 68000+ TOLERANCE				
Size	4H5H		5H MED	EACH
M10 x 1	68104			POA
M12 x 1.25	68124			POA
M14 x 1.25	68144			POA
M18 x 1.5	68184			POA

8 TPI UN 66100+ TOLERANCE				
Size	3B CLOSE	2BMED	EACH	
1 1/8 - 8	66183	66182	POA	
1 1/4 - 8	66204	66202	POA	
1 3/8 - 8	66223	66222	POA	
1 1/2 - 8	66243	66242	POA	
1 5/8 - 8	66263	66262	POA	
1 3/4 - 8	66283	66282	POA	
1 7/8 - 8	66303	66302	POA	
2 - 8	66323	66322	POA	

BSP 61000+ TOLERANCE				
Size	MEDIUM ONLY		EACH	
1/8 - 28			61022	POA
1/4 - 19			61042	POA
3/8 - 19			61062	POA
1/2 - 14			64082	POA
5/8 - 14			61102	POA
3/4 - 14			61122	POA
1" - 11			61162	POA

NPT 66000+ TOLERANCE				
Size	3B CLOSE	2BMED	EACH	
1/8 - 27	66023		POA	
1/4 - 18	66043		POA	
3/8 - 18	66063		POA	
1/2 - 14	66083		POA	
3/4 - 14	66123		POA	
1 - 1 1/2	66163		POA	

BSW 62000+ TOLERANCE				
Size	MEDIUM ONLY		EACH	
1/8 - 40			62022	POA
3/16 - 24			62032	POA
1/4 - 20			62042	POA
5/16 - 18			62052	POA
3/8 - 16			62062	POA
7/16 - 14			62072	POA
1/2 - 12			62082	POA
9/16 - 12			62092	POA
5/8 - 11			62102	POA
3/4 - 10			62122	POA
7/8 - 9			62142	POA
1" - 8			62162	POA
1 1/8 - 7			62182	POA
1 1/4 - 7			62202	POA
1 3/8 - 6			62222	POA
1 1/2 - 6			62242	POA

BSF 60000+ TOLERANCE				
Size	3B CLOSE	2BMED	EACH	
3/16 - 32		60032	POA	
1/4 - 26		60042	POA	
5/16 - 22		60052	POA	
3/8 - 20		60062	POA	
7/16 - 18		60072	POA	
1/2 - 16		60082	POA	
9/16 - 16		60092	POA	
5/8 - 14		60102	POA	
3/4 - 12		60122	POA	
7/8 - 11		60142	POA	
1" - 10		60162	POA	
1 1/4 - 9		60202	POA	

Australian Price List Effective May 2013. Note! All prices are exclusive of GST.
 POA - Price On Application - denotes non-popular parts. Minimum quantities and order values may apply.
 For gauging STI holes i.e. the tapped hole before the insert is installed

Power Installation Tools



SUIT ARO & NR TOOLS FRONT END ASSEMBLY		
Size UNC	Part No.	Price
#2 - 56	53520	418.42
#4 - 40	M8551-04-15	418.42
#5 - 40	M8851-05-15	418.42
#6 - 32	M8551-06-15	418.42
#8 - 32	M8551-2-15	418.42
#10 - 24	M8551-3-15	418.42
1/4 - 20	M8551-4-15	418.42
5/16 - 18	M8251-5-15	377.93
3/8 - 16 ~	M8251-6-16	418.42
7/16 - 14 ~	M8251-7-15	718.73
1/2 - 13 ~	M8251-8-15	718.73
5/8 - 11 ~	53100	647.87
3/4 - 10 ~	53120	647.87

NR SERIES*		SPARE PARTS FOR FRONT END ASSEMBLY				
Part No. NR MOTOR	Price ADAPTOR	MOTOR - ADAPTOR SIZE		FRONT END ASSEMBLY		
		Size UNF	Nozzle Part No.	Price	Mandrel Part No.	Price
NR-HL 1409	1,569.06	#2 - 56	53528	290.200725	53529	151.84
NR-HL 1409	1,569.06	#4 - 40	M8557-04-15	290.200725	M8553-04	151.84
NR-HL 1409	1,569.06	#5 - 40	M8557-05-15	290.200725	M8553-05	151.84
NR-HL 1409	1,569.06	#6 - 32	M8557-06-15	290.200725	M8553-06	151.84
NR-HL 1409	1,569.06	#8 - 32	M8557-2-15	290.200725	M8553-2	151.84
NR-HL 1409	1,569.06	#10 - 24	M8557-3-15	290.200725	M8553-3	151.84
NR-HL 1409	1,569.06	1/4 - 20	M8557-4-15	290.200725	M8553-4	151.84
NR-HL 1410	1,872.75	5/16-18	M8257-5-15	290.200725	M8253-5	151.84
NR-HL 1410	1,872.72	3/8 - 16 ~	M8257-6-15	290.200725	M8253-6	151.84
NR-HL 1410	1,872.75	7/16 - 14 ~	M8257-7-15	290.200725	M8253-7	151.84
NR-HL 1410	1,872.72	1/2 - 13 ~	M8257-8-15	448.785825	M8253-8	219.33
NR-HL 1410	1,872.75	5/8 - 11 ~	53108	448.785825	53109	219.33
NR-HL 1410	1,872.72	3/4 - 10 ~	53128	448.785825	53129	269.94

UNF		
#6 - 40	54560	418.41
#10 - 32	M8552-3-15	418.41
1/4 - 28	M8552-4-15	418.41
5/16 - 24	M8252-5-15	418.41
3/8 - 24 ~	54060	418.41
7/16 - 20 ~	M8252-7-15	718.73
1/2 - 20 ~	M8252-8-15	718.73
5/8 - 18 ~	M8252-9	647.87
3/4 - 16 ~	54120	647.87

UNF						
NR-HL 1409	1,569.06	#6 - 40	54568	290.200725	54569	151.84
NR-HL 1409	1,569.06	#10 - 32	M8558-3-15	290.200725	M8554-3	151.84
NR-HL 1409	1,569.06	1/4 - 28	M8558-4-15	290.200725	M8554-4	151.84
NR-HL 1410	1,872.72	5/16 - 24	M8258-5-15	290.200725	M8254-5	151.84
NR-HL 1410	1,872.75	3/8 - 24 ~	54068	290.200725	54069	151.84
NR-HL 1410	1,872.72	7/16 - 20 ~	M8258-7-15	290.200725	M8254-7	151.84
NR-HL 1410	1,872.75	1/2 - 20 ~	M8258-8-15	448.785825	M8254-8	219.33
NR-HL 1410	1,872.72	5/8 - 18 ~	M8258-9	448.785825	M8254-9	219.33
NR-HL 1410	1,872.75	3/4 - 16 ~	54128	448.785825	54129	269.94

METRIC COARSE		
M2.2 x 0.45	55250	418.42
M2.5 x 0.45	55250	418.42
M3 x 0.5	M8751-3-15	418.42
M3.5 x 0.6	M8751-3.5-15	418.42
M4 x 0.7	M8751-4-15	418.42
M5 x 0.8	M8751-5-15	418.42
M6 x 1	M8751-6-15	418.42
M7 x 1	55070	718.73
M8 x 1.25	M8751-8-15	718.73
M10 x 1.5	M8751-10-15	718.73
M12 x 1.75	M8751-12-15	718.73
M16 x 2	55160	749.10

METRIC COARSE						
NR-HL 1409	1,872.75	M2.2 x 0.45	55258	290.200725	55259	151.84
NR-HL 1409	1,872.75	M2.5 x 0.45	55258	290.200725	55259	151.84
NR-HL 1409	1,872.75	M3 x 0.5	M8769-3-15	290.200725	M8757-3	151.84
NR-HL 1409	1,872.75	M3.5 x 0.6	M8769-3.5-15	290.200725	M8757-3.5	151.84
NR-HL 1409	1,872.75	M4 x 0.7	M8769-4-15	290.200725	M8757-4	151.84
NR-HL 1409	1,872.75	M5 x 0.8	M8769-5-15	290.200725	M8757-5	151.84
NR-HL 1409	1,872.75	M6 x 1	M8769-6-15	290.200725	M8757-6	151.84
NR-HL 1410	1,872.75	M7 x 1	55078	448.785825	55079	151.84
NR-HL 1410	1,872.75	M8 x 1.25	M8769-8-15	448.785825	M8757-8	151.84
NR-HL 1410	1,872.75	M10 x 1.5	M8769-10-15	448.785825	M8757-10	219.33
NR-HL 1410	1,872.75	M12 x 1.75	M8769-12-15	448.785825	M8757-12	269.94
NR-HL 1410	1,872.75	M16 x 2	55168	448.785825	55169	269.94

METRIC FINE		
M8 x 1	57080	718.73
M10 x 1	58100	718.73
M10 x 1.25	57100	718.73
M12 x 1.25	58120	749.10
M12 x 1.5	57120	749.10
M14 x 1.5	M8753-14	718.73

METRIC FINE						
NR-HL 1410	1,872.75	M8 x 1	57088	485.898825	57089	151.84
NR-HL 1410	1,872.75	M10 x 1	58108	485.898825	58109	219.33
NR-HL 1410	1,872.75	M10 x 1.25	57108	485.898825	57109	219.33
NR-HL 1410	1,872.75	M12 x 1.25	58128	485.898825	58129	269.94
NR-HL 1410	1,872.75	M12 x 1.5	57128	485.898825	57129	269.94
NR-HL 1410	1,872.75	M14 x 1.5	M8773-14	485.898825	M8774-14	269.94



Pneumatic Power Tool
(Air motor and adaptor)



Front End Assembly including Mandrel
(1 mandrel only in kit)



Electric Power Tool with Mandrel

Power Installation Tools



PNEUMATIC TANG BREAK-OFF TOOLS		
Size	Part No.	Price
#2 - 56, M2, M2.2	59062	1000.02
#3 - 48, #3 - 56, M2.5	59072	1000.02
#4 - 40, #4 - 48	59082	1000.02
#5 - 40, M3	59092	1000.02
#6 - 32, #6 - 40, M3.5	59102	1000.02
#8 - 32, #8 - 36, M4	59132	1000.02
#10 - 24, #10 - 32, #12 - 24, M5	59142	1000.02
1/4 - 20, 1/4 - 28, M6	59192	1000.02
3/8 - 16, 3/8 - 24, M10	59252	1000.02
1/2 - 12, 1/2 - 13, M12	59332	1000.02
M14 x 1.5	59462	1000.02

WORK-ARM TOOL HOLDER*	Part No.	Price
MANUAL	56000	981.62
PNEUMATIC	WB230B-100	1840.53

POWER TOOL "TOOL BOX"		
Size	Part No.	Price
Type	PTCASE	36.81

Australian Price List Effective May 2013. Note! All prices are exclusive of GST.
 POA - Price On Application - denotes non-popular parts. Minimum quantities and order values may apply.

Workarm/Tool Holder must be used on M2.5, 2.2 and 2-56 inserts.
 NOTE: Front End Assembly suits up to 2D inserts and up to 1.5D for 3/4", M20.
 Use on locking inserts 5/8", M14 and larger is marginal for power.
 ~ No slot provided for strip feed. All other sizes are generally supplied with strip feed slot.

Power Tool "Tool Box" - Provides convenient storage for motor, front end assembly and spanners.

Merchandisers available - Contact customer service or sales representative.



Standard Insertion Tools - Tool Fit Chart

* Includes Square Tap Drive

EXTRACTING TOOLS			
INCH	METRIC	Part No.	Price
#4-40 thru 3/8	M3 thru M10	50002	23.31
#6-32 thru 1"	M4 thru M24	50003	25.77
1 1/8" thru 1 1/2"	M20 thru M39	50004	61.35
1 1/2" thru 2 1/2"	M38 thru M65	50005	122.70

SPRING LOADED TANG BREAK TOOLS - (FOR RAPID TANG REMOVAL)			
Size		Part No.	Price
#2-56, M2, M2.2		59061	128.84
#3-48, #3-56, M2.5		59071	128.84
#4-40, #4-48		59081	128.84
#5-40, M3		59091	128.84
#6-32, #6-40, M3.5		59101	128.84
#8-32, #8-36, M4		59121	128.84
#10-24, #10-32, #12-24, M5		59141	128.84
1/4 - 20, 1/4 - 28, M6		59181	128.84
5/16 - 18, 5/16 - 24, M8		59241	196.32
3/8 - 16, 3/8 - 24, M10		59291	196.32
1/2 - 12, 1/2 - 13, M12		59331	220.86

MAGNETIC TANG BREAK TOOLS - (MANUAL TANG REMOVAL)			
Size		Part No.	Price
M2 x 0.4, UNC #2-56		59060M	5.91
M2.2 x 0.45,		59060M	5.91
M 2.5 x 0.45, UNC #3-48, UNF #3-56, 6BA		59070M	5.91
UNC #4-40, UNF #4-48		59080M	5.91
M3 x 0.5, UNC #5-40, BSW 1/8-40		59090M	5.91
M3.5 x 0.6, UNC #6-32, UNF #6-40, 4BA		59100M	5.91
M4 x 0.7, UNC #8-32, UNF #8-36		59130M	5.91
UNC #10-24, 2BA, BSW 3/16-24		59140M	5.91
M5 x 0.8, UNC #12-24, UNF #12-28, UNF #10-32, BSF 3/16-32		59160M	5.91
M6 x 1, UNC #1/4-20, UNF #1/4-28, OBA, BSF 1/4-26, BSW 1/4-20		59190M	5.91
BSW 5/16-18		59200M	5.91
M7 x 1, UNC #5/16-18		59220M	5.91
M8 x 1, M8 x 1.25, UNF #5/16-24, BSC 5/16-26, BSF 5/16-22		59250M	5.91
M9 X1, M 9 x 1.25, M10-1.5, UNC #3/8-16, UNF #3/8-24, BSW 3/8-16, BSF 3/8-20		59280M	5.91
M10 x 1, M10 x 1.25, UNC #7/16-14, UNF #7/16-20,		59310M	5.91
BSC 3/8-26, BSP 1/8-28, NPT 1/8-27		59310M	5.91
M11 x 1, M11 x 1.25, M11 x 1.5, BSC 7/16-26, BSF 7/16-18, BSW 7/16-14		59340M	5.91
M12 x 1.25, M12 x 1.5, M12 x 1.75, M12 x 1, UNC #1/2-13, UNF #1/2-20		59380M	5.91
BSC 1/2-26, BSF 1/2-16, BSW 1/2-12		59380M	5.91

Australian Price List Effective May 2013. Note! All prices are exclusive of GST.

POA - Price On Application - denotes non-popular parts. Minimum quantities and order values may apply.



Extraction Tool



Spring Loaded Tang Break Tool



Magnetic Tang Break Tool

Standard Insertion Tools - Tool Fit Chart

* Includes Square Tap Drive



Manual Installation Tool



Square Drive Installation Tool with tap

Metric	Part No.	Price \$
M2 x 0.4	50061-20	19.11
M2.2 x 0.45	50061-21	19.11
M 2.5 x 0.45	50069-17	19.11
M3 x 0.5	50089-17	19.11
M3.5 x 0.6	50095-15	19.11
M4 x 0.7	50125-13	19.11
M5 x 0.8	50156-9	13.50
M6 x 1	50188-5	13.50
M7 x 1	50219-4	13.50
M8 x 1, M8 x 1.25	50250-7	13.50
M9 X1, M 9 x 1.25	50281-5	13.50
M10-1.5, M10 x 1.25	50281-4	13.50
M10 x 1	50313-12	13.50
M11 x 1, M11 x 1.25, M11 x 1.5	50334-4	14.72
M12 x 1, M13 x 1.25, M13 x 1.5, M13 x 1.75	50375-0	15.95
M12 x 1.25, M12 x 1.5, M12 x 1.75	50375-1	15.95
M14 x 1.5, M14 x 2, M15 x 1.5, M15 x 2	50438-0	17.18
S/PM14-1.25	50468-0	17.18
M16 x 1.5, M16 x 2	50500-0	17.18
M18 x 1.5 SP, M18 x 1.5, M18 x 2, M18 x 2.5	50591-0	17.18
M20 x 1.5, M20 x 2, M20 x 2.5	50591-0	17.18
M22 x 1.5, M22 x 2, M22 x 2.5	50688	24.54
M24 x 1.5, M24 x 2, M24 x 3	50750	42.95
M26 x 1.5, M27 x 1.5, M27 x 2, M27 x 3	50875	42.95
M30 x 1.5, M30 x 2, M30 x 3, M30 x 3.5	51000	42.95
M33 x 2, M33 x 3.5	51063	61.35
M36 x 1.5, M36 x 3, M36 x 4	51125	61.35
M39 x 2, M39 x 3, M39 x 4	51250	61.35
M42 x 2, M42 x 3, M42 x 4, M42 x 4.5	51250	61.35
M45 x 3, M45 x 4.5	51250	61.35
M48 x 3, M48 x 4, M48 x 5, M52 x 3, M52 x 5	51500	85.89

UNC/UNF	Part No.	Price \$
UNC #2-56	50061-17	19.11
UNC #3-48, UNF #3-56	50069-17	19.11
UNC #4-40, UNF #4-48	50077-17	19.11
UNC #5-40,	50089-18	19.11
UNC #6-32	50095-16	19.11
UNF #6-40	50095-17	19.11
UNC #8-32, UNF #8-36	50125-14	19.11
UNC #10-24	50140-11	19.11
UNC #12-24, UNF #12-28	50156-10	13.50
UNF #10-32	50156-11	13.50
UNC 1/4 - 20, UNF 1/4 - 28	50188-10	13.50
UNC 5/16 - 18	50219-8	13.50
UNF 5/16 - 24	50250-8	13.50
UNC 3/8 - 16	50281-4	13.50
UNF 3/8 - 24	50313-6	13.50
UNC 7/16 - 14	50344-3	14.72
UNF 7/16 - 20	50344-4	14.72

Standard Insertion Tools - Tool Fit Chart

* Includes Square Tap Drive

UNC/UNF	Part No.	Price \$
UNC 1/2 - 13	50375-2	15.95
UNF 1/2 - 20	50375-3	14.72
UNC 9/16 - 12, UNF 9/16 - 18	50438-0	17.18
UNC 5/8 - 11, UNC 11/16 - 11, UNF 5/8 - 18	50500-0	17.18
UNC 3/4 - 10, UNF 3/4 - 16	50591-0	17.18
UNC 7/8 - 9, UNF 7/8 - 14	50688	24.54
UNC 1" - 8, UNF 1" - 12, UNF 1" - 14	50750	42.95
UNC 1 1/8" - 7	50875	42.95
UNC 1 1/4" - 7, UNF 1 1/8" - 12	51000	42.95
UNC 1 3/8" - 6, UNF 1 1/4" - 12	51063	61.35
UNC 1 1/2" - 6, UNF 1 3/8" - 12	51125	61.35
UNF 1 1/2" - 12	51250	61.35
UNC 1 1/2 - 6, UNF 1 3/8 - 12	51125	61.35

BA, BSC, BSF, BSP, BSW, NPT & SPECIALS STANDARD INSERTION TOOLS	Part No.	Price \$
6BA	50077-17	19.11
1/8 - 40	50089-19	19.11
4BA	50095-15	19.11
2BA, 3/16 - 24	50140-9	19.63
3/16 - 32	50156-9	13.50
OBA, BSF 1/4 - 26, BSW 1/4 - 20	50188-5	13.50
BSW 5/16 - 18	50219-8	13.50
BSC 5/16 - 26	50250-4	13.50
BSF 5/16 - 22	50250-5	13.50
BSW 3/8 - 16	50281-4	13.50
BSF 3/8 - 20	50281-5	13.50
BSC 3/8 - 26, BSP 1/8 - 28	50313-5	13.50
BSC 7/16 - 26, BSF 7/16 - 18	50344-4	14.72
BSW 7/16 - 14	50344-1	14.72
BSC 1/2 - 26, BSF 1/2 - 16, BSW 1/2 - 12	50375-1	15.95
BSW 9/16 - 12, BSF 9/16 - 16, BSP 1/4 - 19, NPT 1/4 - 18	50438-0	17.18
BSF 5/8 - 14, BSP 3/8 - 19, NPT 3/8 - 18, 11/16 - 16	50500-0	17.18
BSW 3/4 - 10, BSF 3/4 - 12	50591-0	17.18
BSF 7/8 - 11, BSP 1/2 - 14, BSW 7/8 - 9, NPT 1/2 - 14	50688	24.54
BSF 1" - 10, BSW 1" - 8, 1" - 20	50750	42.95
BSW 1 1/8" - 7, BSP 5/8 - 14, BSW 1 3/8 - 6, NPT 3/4 - 14, UN 1 1/8 - 8	50875	42.95
BSW 1 1/4" - 7, BSF 1 1/4 - 9, UN 1 1/4 - 8	51000	42.95
UN 1 3/8 - 8	51063	61.35
BSP 3/4 - 14, BSW 1 1/2 - 6, NPT 1 11/2	51125	61.35
UN 1 5/8 - 8, UN 1 3/4 - 8	51250	61.35
UN 2 1/2 - 8	52125	38.65

Australian Price List Effective May 2013. Note! All prices are exclusive of GST.

POA - Price On Application - denotes non-popular parts. Minimum quantities and order values may apply.



Manual Installation Tool



Square Drive Installation Tool with tap

Electric Installation Tools - Tool Fit Chart

Metric Series Size	Part No.	Price
M2 x 0.4	55027B	\$135.53
M 2.5 x 0.45	55257B	\$125.10
M3 x 0.5	55037B	\$62.55
M4 x 0.7	55047B	\$62.55
M5 x 0.8	55057B	\$62.55
M6 x 1	55067B	\$62.55
M8 x 1.25	55087B	\$62.55
M10-1.5	55107B	\$62.55
M10 x 1	58107B	\$62.55
M12 x 1.75	55127B	\$62.55
M12 x 1.5	58127B	\$62.55

Inch Series Size	Part No.	Price
UNC #2 - 56	53527B	\$125.10
UNC #4 - 40	53547B	\$62.55
UNC #6 - 32	53567B	\$62.55
UNC #8 - 32	53587B	\$62.55
UNC #10 - 24	53607B	\$62.55
UNF #10 - 32	54607B	\$62.55
UNC 1/4 - 20	53047B	\$62.55
UNF 1/4 - 28	54047B	\$62.55
UNC 5/16 - 18	53057B	\$62.55
UNF 5/16 - 24	54057B	\$62.55
UNC 3/8 - 16	53067B	\$62.55
UNF 3/8 - 24	54067B	\$62.55
UNC 7/16 - 14	53077B	\$62.55
UNF 7/16 - 20	54077B	\$62.55
UNC 1/2 - 13	53087B	\$62.55
UNF 1/2 - 20	54087B	\$62.55

Australian Price List Effective May 2013. Note! All prices are exclusive of GST.

POA - Price On Application - denotes non-popular parts. Minimum quantities and order values may apply.



Electric Mandrel

Power Installation Tools - Tool Fit Chart

LIGHTWEIGHT DESIGN			
Size	Type	Part No.	Price
M6 x 1	LIGHTWEIGHT DESIGN	55062U	86.01
M8 x 1.25	LIGHTWEIGHT DESIGN	55082U	86.01
M10 x 1.25	LIGHTWEIGHT DESIGN	57102U	86.01
M10 x 1.5	LIGHTWEIGHT DESIGN	55102U	86.01
M12 x 1.5	LIGHTWEIGHT DESIGN	57122U	86.01
M12 x 1.75	LIGHTWEIGHT DESIGN	55122U	86.01
#4 - 40	LIGHTWEIGHT DESIGN	53542U	86.01
#6 - 32	LIGHTWEIGHT DESIGN	53562U	86.01
#8 - 32	LIGHTWEIGHT DESIGN	53582U	86.01
#10 - 24	LIGHTWEIGHT DESIGN	53600U	86.01
1/4 - 20	LIGHTWEIGHT DESIGN	53042U	86.01
5/16 - 18	LIGHTWEIGHT DESIGN	53052U	86.01
3/8 - 16	LIGHTWEIGHT DESIGN	53062U	86.01
7/16 - 14	LIGHTWEIGHT DESIGN	53072U	86.01
1/2 - 13	LIGHTWEIGHT DESIGN	53082U	86.01
#10 - 32	LIGHTWEIGHT DESIGN	54602U	86.01
1/4 - 28	LIGHTWEIGHT DESIGN	54042U	86.01
5/16 - 24	LIGHTWEIGHT DESIGN	54052U	86.01
3/8 - 24	LIGHTWEIGHT DESIGN	54062U	86.01
7/16 - 20	LIGHTWEIGHT DESIGN	54072U	86.01
1/2 - 20	LIGHTWEIGHT DESIGN	54082U	86.01

UNC			
Size	Type	Part No.	Price
#2 - 56	PREWINDER	53521	196.32
#3 - 48	MANDREL	53536	117.79
#4 - 40	PREWINDER	53541	196.32
#5 - 40	PREWINDER	53551	196.32
#6 - 32	PREWINDER	53561	196.32
#8 - 32	PREWINDER	53581	196.32
#10 - 24	PREWINDER	53601	196.32
#12 - 24	PREWINDER	53621	196.32
1/4 - 20	PREWINDER	53041	196.32
5/16 - 18	PREWINDER	53051	215.96
3/8 - 16	PREWINDER	53061	225.77
7/16 - 14	PREWINDER	53071	225.77
1/2 - 13	PREWINDER	53081	245.40
9/16 - 12	MANDREL	53096	78.53
5/8 - 11	MANDREL	53106	78.53
3/4 - 10	MANDREL	53126	88.35
7/8 - 9	MANDREL	53146	98.16
1" - 8	MANDREL	53166	117.79
1 1/8 - 7	MANDREL	53186	127.61
1 1/4 - 7	MANDREL	53206	137.43
1 3/8 - 6	MANDREL	53226	147.24
1 1/2 - 6	MANDREL	53246	157.06

METRIC			
Size	Type	Part No.	Price
M2.2 x 0.45	PREWINDER	55011	294.49
M2.5 x 0.45	PREWINDER	55251	245.40
M3 x 0.5	PREWINDER	55031	245.40
M3.5 x 0.6	PREWINDER	55351	245.40
M4 x 0.7	PREWINDER	55041	245.40
M5 x 0.8	PREWINDER	55051	245.40
M6 x 1	PREWINDER	55061	245.40
M7 x 1	PREWINDER	55071	245.40
M8 x 1.25	PREWINDER	55081	245.40
M10 x 1.5	PREWINDER	55101	245.40
M12 x 1.75	PREWINDER	55121	245.40
M14 x 2	MANDREL	55146	147.24
M16 x 2	MANDREL	55166	147.24
M18 x 2.5	MANDREL	55186	147.24
M8 x 1	PREWINDER	57081	245.40
M10 x 1	PREWINDER	58101	245.40
M10 x 1.25	PREWINDER	57101	245.40
M12 x 1.25	PREWINDER	58121	245.40
M12 x 1.5	PREWINDER	57121	245.40
M14 x 1.5	NON CAPTIVE	57141	588.97
M16 x 1.5	NON CAPTIVE	57161	638.05
M18 x 1.5	NON CAPTIVE	58181	687.13

UNF			
Size	Type	Part No.	Price
#3 - 56	PREWINDER	54531	215.96
#4 - 48	PREWINDER	54541	215.96
#6 - 40	PREWINDER	54561	215.96
#8 - 36	PREWINDER	54581	215.96
#10 - 32	PREWINDER	54601	215.96
1/4 - 20	PREWINDER	54041	215.96
5/16 - 24	PREWINDER	54051	215.96
3/8 - 24	PREWINDER	54061	215.96
7/16 - 20	PREWINDER	54071	245.40
1/2 - 20	PREWINDER	54081	245.40
9/16 - 18	NON CAPTIVE	54091	392.65
5/8 - 18	NON CAPTIVE	54101	588.97
3/4 - 16	NON CAPTIVE	54121	883.46
7/8 - 14	NON CAPTIVE	54141	883.46
1" - 14	NON CAPTIVE	54171	883.46
1" - 12	NON CAPTIVE	54161	883.46
1 1/8 - 12	NON CAPTIVE	54181	883.46

Australian Price List Effective May 2013. Note! All prices are exclusive of GST.

POA - Price On Application - denotes non-popular parts. Minimum quantities and order values may apply.



'Prewinder' Non Captive Type Installation Tool



Semi Production 'Pre-Winder' Type Installation Tool - Metal Body



Non-Captive 'Pre-Winder' Type Installation Tool - Aluminium Body

Carbon Steel Bulk Keyserts - Metric

Minimum pack quantities apply



INTERNAL		EXTERNAL		KEYSERT PRICE each						Installation Tool	
Thread Size	Thread Class	Length	Drill	Part	MIN					Part	Price
CLASS 6H	CLASS 6G	(mm)	Size	No.	Qty	*	100+	500+	1000+	No.	\$
LIGHTWEIGHT - METRIC SERIES - CARBON STEEL											
M5 x 0.8	M8 x 1.25	8	6.9	75051	5	7.61	6.09	5.48	5.20	72190	40.66
M6 x 1	M10 x 1.25	10	8.8	75061	5	8.45	6.77	6.09	5.78	72250	41.95
M8 x 1.25	M12 x 1.25	12	10.8	75081	5	9.31	7.44	6.70	6.37	72312	43.58
M8 x 1			10.8	77081	5	9.31	7.44	6.70	6.37	72312	43.58
M10 x 1.5	M14 x 1.5	14	12.8	75101	4	11.45	9.15	8.25	7.82	72375	46.82
M10 x 1.25			12.8	77101	4	11.45	9.15	8.25	7.82	72375	46.82
M12 x 1.75	M16 x 1.5	16	14.75	75121	4	14.76	11.81	10.63	10.10	72500	53.21
M12 x 1.25			14.75	78121	4	14.76	11.81	10.63	10.10	72500	53.21

HEAVY DUTY - METRIC SERIES - CARBON STEEL											
M4 x 0.7	M8 x 1.25	8	6.90	75042	3	15.08	12.07	10.86	10.32	71042	65.03
M5 x 0.8	M10 x 1.25	10	8.80	75052	5	7.61	6.09	5.48	5.20	72190	40.66
M6 x 1	M12 x 1.25	12	10.80	75062	5	8.45	6.77	6.09	5.78	72250	41.95
M8 x 1.25	M14 x 1.5	14	12.80	75082	5	9.31	7.44	6.70	6.37	72312	43.58
M8 x 1			12.80	77082	5	9.31	7.44	6.70	6.37	72312	43.58
M10 x 1.5	M16 x 1.5	16	14.75	75102	4	11.45	9.15	8.25	7.82	72375	46.82
M10 x 1.25			14.75	77102	4	11.45	9.15	8.25	7.82	72375	46.82
M12 x 1.75	M18 x 1.5	18	16.75	75122	4	14.76	11.81	10.63	10.10	72500	53.21
M12 x 1.25			16.75	78122	4	14.76	11.81	10.63	10.10	72500	53.21
M14 x 2	M20 x 1.5	20	18.75	75142	3	17.82	14.25	12.83	12.19	72500	53.21
M14 x 1.5			18.75	77142	3	17.82	14.25	12.83	12.19	72500	53.21
M16 x 2	M22 x 1.5	22	20.50	75162	2	21.14	16.91	15.22	14.47	72625	56.91
M16 x 1.5			20.50	77162	2	21.14	16.91	15.22	14.47	72625	56.91
M18 x 1.5	M24 x 1.5	24	22.50	78182	1	31.55	25.23	22.71	21.58	71182	56.91
M20 x 2.5	M30 x 2	30	28.00	75202	1	36.95	29.54			72875	60.30
M20 x 1.5			28.00	78202	1	36.95	29.54			72875	60.30
M22 x 1.5	M32 x 2	32	30.00	78222	1	44.61	35.68			71222	60.30
M24 x 3	M33 x 2	33	31.00	75242	1	59.83	47.86			71242	82.76
M24 x 2			31.00	77242	1	59.83	47.86			71242	82.76

SOLID - METRIC - CARBON STEEL											
EXTERNAL		KEYSERT PRICE each									
Thread Class (mm)	Length	Drill	Part	MIN	Price						
CLASS 6G	(mm)	Size	No.	Qty	\$						
M8 x 1.25	8	6.90	75084	1	37.53						
M10 x 1.25	10	8.80	77104	1	39.54						
M12 x 1.25	12	10.80	78124	1	42.21						
M14 x 1.5	14	12.80	77144	1	52.74						
M16 x 1.5	16	14.75	77164	1	58.66						
M18 x 1.5	18	16.75	78184	1	65.88						
M20 x 1.5	20	18.75	78204	1	73.35						
M22 x 1.5	22	20.50	78224	1	108.99						
M24 x 2	24	22.50	78244	1	108.99						
M30 x 2	30	28.00	77304	1	116.67						
M32 x 2	32	30.00	77322	1	122.26						
M33 x 2	33	31.00	77332	1	131.18						

* Refer to Minimum Qty

Australian Price List Effective May 2013. Note! All prices are exclusive of GST.

POA - Price On Application - denotes non-popular parts. Minimum quantities and order values may apply.

Carbon Steel Bulk Keyserts - Inch

Minimum pack quantities apply



INTERNAL Thread Size Class 2B	EXTERNAL Thread 2A (MOD)	Length (mm)	Drill Size	KEYSERT PRICE each						Installation Tool	
				Part No.	MIN Qty	*	100+	500+	1000+	Part No.	Price \$
LIGHTWEIGHT - INCH SERIES - CARBON STEEL											
#10-24	5/16-18	0.31	1 (.2720")	73601	8	4.88	3.90	3.51	3.34	72190	40.66
#10-32			1 (.2720")	74601	8	4.88	3.90	3.51	3.34	72190	40.66
1/4-20	3/8-16	0.37	Q (.3320")	73041	7	5.14	4.11	3.70	3.52	72250	41.95
1/4-28			Q (.3320")	74041	7	5.14	4.11	3.70	3.52	72250	41.95
5/16-18	7/16-14	0.43	X (.3970")	73051	7	5.79	4.63	4.18	3.95	72312	43.58
5/16-24			X (.3970")	74051	7	5.79	4.63	4.18	3.95	72312	43.58
3/8-16	1/2-13	0.50	29/64	73061	7	6.38	5.09	4.59	4.37	72375	46.82
3/8-24			29/64	74061	7	6.38	5.09	4.59	4.37	72375	46.82
7/16-14	9/16-12	0.56	33/64	73071	7	8.27	6.61	5.95	5.65	72375	46.82
7/16-20			33/64	74071	7	8.27	6.61	5.95	5.65	72375	46.82
1/2-13	5/8-11	0.62	37/64	73081	7	9.57	7.65	6.88	6.55	72500	53.21
1/2-20			37/64	74081	7	9.57	7.65	6.88	6.55	72500	53.21

HEAVY DUTY - INCH SERIES - CARBON STEEL											
#8-32	5/16-18	0.31	1 (.2720")	73582	7	8.13	6.50	5.86	5.57	70582	148.04
#10-24	3/8-16	0.31	Q (.3320")	73602	8	4.88	3.90	3.51	3.34	72190	40.66
#10-32			Q (.3320")	74602	8	4.88	3.90	3.51	3.34	72190	40.66
1/4-20	7/16-14	0.37	X (.3970")	73042	7	5.14	4.11	3.70	3.52	72250	41.95
1/4-28			X (.3970")	74042	7	5.14	4.11	3.70	3.52	72250	41.95
5/16-18	1/2-13	0.43	29/64	73052	7	5.72	4.57	4.11	3.91	72312	43.58
5/16-24			29/64	74052	7	5.72	4.57	4.11	3.91	72312	43.58
3/8-16	9/16-12	0.50	33/64	73062	7	6.38	5.09	4.59	4.37	72375	46.82
3/8-24			33/64	74062	7	6.38	5.09	4.59	4.37	72375	46.82
7/16-14	5/8-11	0.62	37/64	73072	7	8.13	6.51	5.86	5.57	72375	46.82
7/16-20			37/64	74072	7	8.13	6.51	5.86	5.57	72375	46.82
1/2-13	3/4-16	0.62	45/64	73082	7	9.57	7.65	6.88	6.55	72500	53.21
1/2-20			45/64	74082	7	9.57	7.65	6.88	6.55	72500	53.21
9/16-12	3/4-16	0.81	45/64	73092	4	13.07	10.46	9.41	8.96	72500	53.21
9/16-18			45/64	74092	4	13.07	10.46	9.41	8.96	72500	53.21
5/8-11	7/8-14	0.87	53/64	73102	3	15.42	12.66	11.11	10.54	72635	70.43
5/8-18			53/64	74102	3	15.42	12.66	11.11	10.54	72625	56.91
3/4-10	1 1/8-12	1.12	11/16	73122	2	21.98	17.58	15.82	15.04	72875	60.30
3/4-16			11/16	74122	2	21.98	17.58	15.82	15.04	72875	60.30
7/8-9	1 1/4-12	1.25	13/16	73142	1	28.74	23.00	20.70	19.66	72875	60.30
7/8-14			13/16	74142	1	28.74	23.00	20.70	19.66	72875	60.30
1"-8			15/16	73162	1	58.27	46.61	41.95	39.85	72100	70.94
1"-12	1 3/8-12	1.37	15/16	74162	1	58.27	46.61	41.95	39.85	72100	70.94
1"-14			15/16	74162-14	1	58.27	46.61	41.95	39.85	70162	117.80
1 1/8-7	1/12-12	1.62	17/16	73182	1	140.47	112.37			70182	273.14
1 1/8-12			17/16	74182	1	140.47	112.37			70182	273.14
1 1/4-7	1 5/8-12	1.81	19/16	73202	1	172.53	138.03			70202	295.03
1 1/4-12			16/16	74202	1	172.53	138.03			70202	295.03
1 1/2-6	1 7/8-12	2.00	1 13/16	73242	1	332.19				70242	295.03
1 1/2-12			1 13/16	74242	1	332.19				70242	295.03

SOLID - METRIC - CARBON STEEL											
EXTERNAL Thread Class 2B	Length (mm)	KEYSERT PRICE each									
		Drill Size	Part No.	MIN Qty	Price \$						
5/16-18	0.31	1 (.2720")	73054	1	36.10						
3/8-16	0.31	Q (.3320")	73064	1	37.98						
7/16-14	0.37	X (.3970")	73074	1	40.44						
1/2-13	0.43	29/64	73084	1	50.92						
9/16-12	0.5	33/64	73094	1	56.65						
5/8-11	0.62	37/64	73104	1	63.81						
3/4-16	0.68	45/64	73124	1	71.28						
7/8-14	0.87	53/64	73144	1	81.81						
1 - 12	0.87	15/16	74164	1	107.17						
1 1/8 - 12	1.12	1 1/16	74184	1	114.79						
1 1/4 - 12	1.25	1 3/16	74204	1	120.51						
1 3/8 - 12	1.37	1 5/16	74224	1	129.41						

* Refer to Minimum Qty

Stainless Steel Bulk Keyserts

Lightweight/heavy Duty Metric Stainless Steel - minimum pack quantities apply



INTERNAL Thread Class 6H	EXTERNAL Thread Class Class 6G	Length (mm)	KEYSERT PRICE each							Installation Tool		
			Drill Size	Part No.	MIN			100+	500+	1000+	Part No.	Price \$
					Qty *	100+	500+					
M5 x 0.8	M8 x 1.25	8	6.9	75056	2	16.32	13.87	11.79	10.61	72190	40.66	
M6 x 1	M10 x 1.25	10	8.8	75066	2	16.87	14.34	12.19	10.98	72250	41.95	
M8 x 1.25	M12 x 1.25	12	10.8	75086	2	17.38	14.79	12.55	11.30	72312	43.58	
M8 x 1			10.8	77086	2	17.38	14.79	12.55	11.30	72312	43.58	
M10 x 1.5	M14 x 1.5	14	12.8	75106	2	17.90	15.22	12.94	11.63	72375	46.82	
M10 x 1.25			12.8	77106	2	17.90	15.22	12.94	11.63	72375	46.82	
M12 x 1.75	M16 x 1.5	16	14.75	75126	2	19.89	16.91	14.37	12.94	72500	53.21	
M12 x 1.25			14.75	78126	2	19.89	16.91	14.37	12.94	72500	53.21	

HEAVY DUTY - METRIC SERIES - STAINLESS STEEL											
M4 x 0.7	M8 x 1.25	8	6.90	75047	2	20.27	17.23	14.64	13.18	71042	65.03
M5 x 0.8	M10 x 1.25	10	8.80	75057	2	20.72	17.60	14.97	13.47	72250	41.95
M6 x 1	M12 x 1.25	12	10.80	75067	2	21.84	18.56	15.77	14.20	72250	41.95
M8 x 1.25	M14 x 1.5	14	12.80	75087	2	22.97	19.54	16.60	14.93	72312	43.58
M8 x 1			12.80	77087	2	22.97	19.54	16.60	14.93	72312	43.58
M10 x 1.5	M16 x 1.5	16	14.75	75107	2	24.11	20.49	17.42	15.68	72375	46.82
M10 x 1.25			14.75	77107	2	24.11	20.49	17.42	15.68	72375	46.82
M12 x 1.75	M18 x 1.5	18	16.75	75127	2	25.23	21.45	18.23	16.41	72500	53.21
M12 x 1.25			16.75	78127	2	25.23	21.45	18.23	16.41	72500	53.21
M14 x 2	M20 x 1.5	20	18.75	75147	1	28.69	24.38	20.73	18.64	72500	53.21
M14 x 1.5			18.75	77147	1	28.68	24.38	20.73	18.64	72500	53.21
M16 x 2	M22 x 1.5	22	20.50	75167	1	37.17	31.59	26.86	24.17	72625	56.91
M16 x 1.5			20.50	77167	1	37.17	31.59	26.86	24.17	72625	56.91
M18 x 1.5	M24 x 1.5	24	22.50	78187	1	71.70	60.94	51.80	46.62	71182	
M20 x 2.5	M30 x 2	30	28.00	75207	1	71.70	60.94	51.80	46.62	72875	60.30
M20 x 1.5			28.00	78207	1	71.70	60.94	51.80	46.62	72875	60.30
M22 x 1.5	M32 x 2	32	30.00	78227	1	77.01	65.46	55.64	50.07	71222	
M24 x 3	M33 x 2	33	31.00	75247	1	77.01	65.46	55.64	50.07	71242	82.76
M24 x 2			31.00	77247	1	114.15	97.02	82.47	74.22	71242	82.76

* Refer to Minimum Qty

Australian Price List Effective May 2013. Note! All prices are exclusive of GST.

POA - Price On Application - denotes non-popular parts. Minimum quantities and order values may apply.

Stainless Steel Bulk Keyserts

Minimum pack quantities apply



INTERNAL Thread Size	EXTERNAL Thread Class	Length (mm)	KEYSERT PRICE each							Installation Tool		
			Drill Size	Part No.	MIN Qty	*	100+	500+	1000+	PART No.	PRICE \$	
Class 2B	Class 6G	(mm)										
LIGHTWEIGHT SERIES - STAINLESS STEEL												
#10 - 24	5/16 - 18	0.31	1 (.2720")	73606	4	8.00	6.41	5.76	5.47	72190	40.66	
#10 - 32			1 (.2720")	74606	4	8.00	6.41	5.76	5.47	72190	40.66	
1/4 - 20	3/8 - 16	0.37	Q (.3320")	73046	4	8.40	6.72	6.04	5.74	72250	41.95	
1/4 - 28			Q (.3320")	74046	4	8.40	6.72	6.04	5.74	72250	41.95	
5/16 - 18	7/16 - 14	0.43	X (.3970")	73056	3	13.72	10.98	9.89	9.39	72312	43.58	
5/16 - 24			X (.3970")	74056	3	13.72	10.98	9.89	9.39	72312	43.58	
3/8 - 16	1/2 - 13	0.50	29/64	73066	3	16.85	13.48	12.13	11.53	72375	46.82	
3/8 - 24			29/64	74066	3	16.85	13.48	12.13	11.53	72375	46.82	
7/16 - 14	9/16 - 12	0.56	33/64	73076	2	24.91	19.93	17.94	17.04	72375	46.82	
7/16 - 20			33/64	74076	2	24.91	19.93	17.94	17.04	72375	46.82	
1/2 - 13	5/8 - 11	0.62	37/64	73086	2	26.53	21.23	19.11	18.15	72500	53.21	
1/2 - 20			37/64	74086	2	26.53	21.23	19.11	18.15	72500	53.21	

HEAVY DUTY - INCH SERIES - STAINLESS STEEL												
#8 - 32	5/16 - 18	0.31	1 (.2720")	73587	3	7.61	6.09	5.48	5.20	70582	148.04	
#10 - 24	3/8 - 16	0.31	Q (.3320")	73607	3	8.40	6.72	6.04	5.74	72190	40.66	
#10 - 32			Q (.3320")	74607	3	8.40	6.72	6.04	5.74	72190	40.66	
1/4 - 20	7/16 - 14	0.37	X (.3970")	73047	3	9.11	7.28	6.55	6.23	72250	41.95	
1/4 - 28			X (.3970")	74047	3	9.11	7.28	6.55	6.23	72250	41.95	
5/16 - 18	1/2 - 13	0.43	29/64	73057	2	13.60	10.87	9.79	9.31	72312	43.58	
5/16 - 24			29/64	74057	2	13.60	10.87	9.79	9.31	72312	43.58	
3/8 - 16	9/16 - 12	0.50	33/64	73067	2	15.87	12.70	11.43	10.85	72375	46.82	
3/8 - 24			33/64	74067	2	15.87	12.70	11.43	10.85	72375	46.82	
7/16 - 14	5/8 - 11	0.62	37/64	73077	2	23.35	18.69	16.82	15.98	72375	46.82	
7/16 - 20			37/64	74077	2	23.35	18.69	16.82	15.98	72375	46.82	
1/2 - 13	1 1/16 - 11NS	0.62	45/64	73087	2	28.55	22.84	20.57	19.54	72500	53.21	
1/2 - 20			45/64	74087	2	28.55	22.84	20.57	19.54	72500	53.21	
9/16 - 12	3/4 - 16	0.81	45/64	73097	2	30.30	24.24	21.81	20.74	72500	53.21	
9/16 - 18			45/64	74097	2	30.30	24.24	21.81	20.74	72500	53.21	
5/8 - 11	7/8 - 14	0.87	53/64	73107	2	38.05	30.43	27.39	26.02	72625	56.91	
5/8 - 18			53/64	74107	2	38.05	30.43	27.39	26.02	72625	56.91	
3/4 - 10	1 1/8 - 12	1.12	1 1/16	73127	2	44.69	35.75	32.17	30.57	72875	60.30	
3/4 - 16			1 1/16	74127	2	44.69	35.75	32.17	30.57	72875	60.30	
7/8 - 9	1 1/4 - 12	1.25	1 3/16	73147	1					72875	60.30	
7/8 - 14			1 3/16	74147	1					72875	60.30	
1" - 8	1 3/8 - 12	1.37	1 5/16	73167	1					72100	70.94	
1" - 12			1 5/16	74167	1					72100	70.94	

SOLID - INCH - STAINLESS STEEL					
EXTERNAL Thread Class 2B	Length (inch) (Modified)	Drill Size	Part No.	MIN Qty	Price \$
5/16 - 18	0.31	1 (.2720")	73059	1	
3/8 - 16	0.31	Q (.3320")	73069	1	50.80
7/16 - 14	0.37	X (.3970")	73079	1	54.67
1/2 - 13	0.43	37/64	73089	1	89.74
9/16 - 12	0.5	45/64	73099	1	104.00
5/8 - 11	0.62	53/64	73109	1	118.18
3/4 - 16	0.68	1 1/16	73129	1	167.12
7/8 - 14	0.87	1 3/16	73149	1	216.10
1" - 12	0.87	1 5/16	74169	1	316.25
1 1/8 - 12	1.12	1 7/16	74189	1	353.98
1 1/4 - 12	1.25	1 9/16	74209	1	416.34
1 3/8 - 12	1.37	1 5/16	74229	1	451.06

* Refer to Minimum Qty

Australian Price List Effective May 2013. Note! All prices are exclusive of GST.

POA - Price On Application - denotes non-popular parts. Minimum quantities and order values may apply.

Carbon & Stainless Steel Keysert Thread Insert

Replacement packets



LIGHTWEIGHT - INCH SERIES - CARBON STEEL			
INTERNAL			
Thread Size	Part No.	Qty per/pkt	Price \$/pkt
Class 2B			
#10 - 24	73601P	8	39.06
#10 - 32	74601P	8	39.06
1/4 - 20	73041P	7	36.00
1/4 - 28	74041P	7	36.00

INTERNAL			
Thread Size	Part No.	Qty per/pkt	Price \$/pkt
CLASS 2B			
5/16 - 18	73051P	7	39.06
5/16 - 24	74051P	7	39.06
3/8 - 16	73061P	7	36.00
3/8 - 24	74061P	7	36.00

INTERNAL			
Thread Size	Part No.	Qty per/pkt	Price \$/pkt
CLASS 2B			
7/16 - 14	73071P	7	39.06
7/16 - 20	74071P	7	39.06
1/2 - 13	73081P	7	36.00
1/2 - 20	74081P	7	36.00

LIGHTWEIGHT - METRIC SERIES - CARBON STEEL			
INTERNAL			
Thread Size	Part No.	Qty per/pkt	Price \$/pkt
Class 6H			
M5 x 0.8	75051P	5	38.07
M6 x 1	75061P	5	42.27
M8 x 1.25	75081P	5	46.52
M8 x 1	77081P	5	46.52

INTERNAL			
Thread Size	Part No.	Qty per/pkt	Price \$/pkt
CLASS 6H			
M10 x 1.5	75101P	4	38.07
M10 x 1.25	77101P	4	42.27
M12 x 1.75	75121P	4	46.52
M12 x 1.25	78121P	4	46.52

STAINLESS STEEL KEYSERT THREAD INSERTS REPLACEMENT PACKETS			
INTERNAL			
Thread Size	Part No.	Qty per/pkt	Price \$/pkt
Class 2B			
#10 - 24	73606P	4	32.02
#10 - 32	74606P	4	32.02
1/4 - 20	73046P	4	33.58
1/4 - 28	74046P	4	33.58

INTERNAL			
Thread Size	Part No.	Qty per/pkt	Price \$/pkt
CLASS 2B			
5/16 - 18	73056P	3	32.02
5/16 - 24	74056P	3	32.02
3/8 - 16	73066P	3	33.58
3/8 - 24	74066P	3	33.58

INTERNAL			
Thread Size	Part No.	Qty per/pkt	Price \$/pkt
CLASS 2B			
7/16 - 14	73076P	2	32.02
7/16 - 20	74076P	2	32.02
1/2 - 13	73086P	2	33.58
1/2 - 20	74086P	2	33.58

LIGHTWEIGHT - METRIC SERIES - STAINLESS STEEL			
INTERNAL			
Thread Size	Part No.	Qty per/pkt	Price \$/pkt
Class 6H			
M5 x 0.8	75056P	2	32.63
M6 x 1	75066P	2	33.75
M8 x 1.25	75086P	2	34.77
M8 x 1	77086P	2	34.77

INTERNAL			
Thread Size	Part No.	Qty per/pkt	Price \$/pkt
CLASS 6H			
M10 x 1.5	75106P	2	32.63
M10 x 1.25	77106P	2	33.75
M12 x 1.75	75126P	2	34.77
M12 x 1.25	78126P	2	34.77

Australian Price List Effective May 2013. Note! All prices are exclusive of GST.
POA - Price On Application - denotes non-popular parts. Minimum quantities and order values may apply.

The Recoil Tapper System - Metric

Sizes normally available ex stock. Lead times and minimums may apply on all other sizes. A wider range of sizes and materials available on request. Contact AFS for further information

METRIC					
302 SERIES					
STANDARD TAPPER FOR METALS, WOOD AND PLASTICS					
STEEL, CASE HARDENED, ZINC PLATED					
Part No.	Internal Thread	PRICE EACH			
		10 - 99	100 - 999	1,000+	
3020030.16	M3	0.637	0.573	0.531	
3020035.16	M3.5	0.729	0.655	0.605	
* 3020040.16	M4	0.811	0.730	0.676	
* 3020050.16	M5	0.917	0.825	0.764	
* 3020061.16	M6(a)	1.099	0.989	0.915	
* 3020060.16	M6	1.216	1.094	1.012	
* 3020080.16	M8	1.611	1.450	1.341	
* 3020100.16	M10 x 1.5	2.407	2.166	2.003	
* 3020106.16	M10 x 1.25	2.407	2.166	2.003	
* 3020120.16	M12 x 1.75	3.374	3.037	2.810	
* 3020127.16	M12 x 1.5	3.374	3.037	2.810	
* 3020140.16	M14	4.170	3.753	3.472	
* 3020160.16	M16	5.544	4.988	4.616	
3020180.16	M18	7.741	6.967	6.443	
3020200.16	M20	11.137	10.023	9.271	

302.....40 SERIES					
STANDARD TAPPER FOR METALS, WOOD AND PLASTICS					
STAINLESS STEEL (304)					
Part No.	Internal Thread	PRICE EACH			
		10 - 99	100 - 999	1,000+	
3020030.40	M3	1.278	1.151	1.063	
3020035.40	M3.5	1.471	1.325	1.224	
3020040.40	M4	1.630	1.468	1.356	
3020050.40	M5	1.855	1.669	1.543	
3020061.40	M6(a)	2.213	1.992	1.841	
* 3020060.40	M6	2.455	2.209	2.044	
* 3020080.40	M8	3.247	2.923	2.704	
3020100.40	M10	4.857	4.369	4.043	
3020120.40	M12	9.752	8.777	8.119	
3020140.40	M14	11.768	10.591	9.795	
3020160.40	M16	14.822	13.340	12.338	
3020180.40	M18	18.165	16.347	15.121	
3020200.40	M20	23.611	21.250	19.656	

305 SERIES					
STANDARD TAPPER FOR SOFT THERMO PLASTICS					
BRASS					
Part No.	Internal Thread	PRICE EACH			
		10 - 99	100 - 999	1,000+	
* 3050030.80	M3	0.507	0.458	0.422	
3050035.80	M3.5	0.537	0.484	0.447	
* 3050040.80	M4	0.562	0.505	0.467	
* 3050050.80	M5	0.786	0.707	0.655	
3050060.80	M6	1.051	0.943	0.874	

* SIZES NORMALLY AVAILABLE EX STOCK. LEAD TIME AND MINIMUMS MAY APPLY ON ALL OTHER SIZES
A WIDER RANGE OF SIZES AND MATERIALS AVAILABLE ON REQUEST. CONTACT AFS FOR FURTHER INFORMATION

Australian Price List Effective May 2013. Note! All prices are exclusive of GST.

POA - Price On Application - denotes non-popular parts. Minimum quantities and order values may apply.



The Recoil Tapper System - Metric

Sizes normally available ex stock. Lead times and minimums may apply on all other sizes. A wider range of sizes and materials available on request. Contact AFS for further information

METRIC 307 SERIES STANDARD TAPPER FOR METALS AND PLASTICS (SHORT VERSION) STEEL, CASE HARDENED, ZINC PLATED, YELLOW CHROMATED					
Part No.	Internal Thread	PRICE EACH			
		10 - 99	100 - 999	1,000+	
* 3070030.16	M3	1.343	1.208	1.117	
3070035.16	M3.5	1.158	1.043	0.964	
* 3070040.16	M4	1.272	1.145	1.058	
* 3070050.16	M5	1.401	1.260	1.167	
* 3070060.16	M6	1.636	1.471	1.360	
* 3070080.16	M8	1.896	1.708	1.578	
* 3070100.16	M10	2.531	2.277	2.107	
3070120.16	M12	3.665	3.300	3.050	
3070140.16	M14	4.812	4.331	4.006	
3070160.16	M16	6.715	6.042	5.591	

METRIC 308 SERIES STANDARD TAPPER FOR METALS AND PLASTICS (LONG VERSION) STEEL, CASE HARDENED, ZINC PLATED, YELLOW CHROMATED					
Part No.	Internal Thread	PRICE EACH			
		10 - 99	100 - 999	1,000+	
* 3080030.16	M3	1.387	1.249	1.155	
3080035.16	M3.5	1.247	1.122	1.037	
* 3080040.16	M4	1.283	1.155	1.069	
* 3080050.16	M5	1.422	1.280	1.183	
^ 3080060.16	M6	1.945	1.750	1.619	
* 3080080.16	M8	2.183	1.964	1.815	
* 3080100.16	M10	2.824	2.542	2.351	
3080120.16	M12	4.275	3.847	3.559	
3080140.16	M14	4.968	4.471	4.137	
3080160.16	M16	7.233	6.509	6.020	

METRIC 309 SERIES STANDARD TAPPER FOR SOFTWOODS AND PLASTICS BRASS					
Part No.	Internal Thread	PRICE EACH			
		10 - 99	100 - 999	1,000+	
3090025.80	M2.5	0.583	0.524	0.485	
* 3090030.80	M3	0.603	0.542	0.501	
3090035.80	M3.5	0.666	0.599	0.556	
* 3090040.80	M4	0.750	0.676	0.623	
* 3090050.80	M5	0.967	0.870	0.804	
* 3090060.80	M6	1.666	1.497	1.387	
* 3090080.80	M8	2.284	2.055	1.902	
* 3090100.80	M10	3.999	3.600	3.330	
3090120.80	M12	6.345	5.711	5.281	
3090160.80	M16	9.086	8.178	7.564	

* SIZES NORMALLY AVAILABLE EX STOCK. LEAD TIME AND MINIMUMS MAY APPLY ON ALL OTHER SIZES
A WIDER RANGE OF SIZES AND MATERIALS AVAILABLE ON REQUEST. CONTACT AFS FOR FURTHER INFORMATION



Australian Price List Effective May 2013. Note! All prices are exclusive of GST.

POA - Price On Application - denotes non-popular parts. Minimum quantities and order values may apply.

The Recoil Tapper System - Inch

Sizes normally available ex stock. Lead times and minimums may apply on all other sizes. A wider range of sizes and materials available on request. Contact AFS for further information

UNC / UNF
302 SERIES
STANDARD TAPPER FOR METALS AND PLASTICS (SHORT VERSION)
STEEL, CASE HARDENED, ZINC PLATED

Part No.	Internal Thread	PRICE EACH		
		10 - 99	100 - 999	1,000+
3020604.16	No. 4 UNC	0.73	0.66	0.61
3020704.16	No. 4 UNF	0.73	0.66	0.61
3020605.16	No. 5 UNC	0.73	0.66	0.61
3020705.16	No. 5 UNF	0.73	0.66	0.61
3020606.16	No. 6 UNC	0.84	0.75	0.70
3020706.16	No. 6 UNF	0.84	0.75	0.70
3020608.16	No. 8 UNC	0.93	0.84	0.78
3020708.16	No. 8 UNF	0.93	0.84	0.78
3020610.16	No. 10 UNC	1.06	0.95	0.88
* 3020710.16	No. 10 UNF	1.06	0.95	0.88
3020612.16	No. 12 UNC	1.40	1.26	1.16
3020712.16	No. 12 UNF	1.40	1.26	1.16
* 3020625.16	1/4 - 20 UNC	1.40	1.26	1.16
* 3020725.16	1/4 - 28 UNF	1.40	1.26	1.16
* 3020631.16	5/16 - 18 UNC	1.85	1.67	1.54
* 3020731.16	5/16 - 24 UNF	1.85	1.67	1.54
* 3020637.16	3/8 - 16 UNC	2.77	2.49	2.30
* 3020737.16	3/8 - 24 UNF	2.77	2.49	2.30
* 3020644.16	7/16 - 14 UNC	3.88	3.49	3.23
* 3020744.16	7/16 - 20 UNF	3.88	3.49	3.23
* 3020650.16	1/2 - 13 UNC	4.80	4.32	3.99
3020750.16	1/2 - 20 UNF	4.80	4.32	3.99
3020656.16	9/16 - 12 UNC	4.80	4.32	3.99
3020756.16	9/16 - 18 UNF	4.80	4.32	3.99
* 3020662.16	5/8 - 11 UNC	6.37	5.74	5.31
3020762.16	5/8 - 18 UNF	6.37	5.74	9.22

* SIZES NORMALLY AVAILABLE EX STOCK. LEAD TIME AND MINIMUMS MAY APPLY ON ALL OTHER SIZES
A WIDER RANGE OF SIZES AND MATERIALS AVAILABLE ON REQUEST. CONTACT AFS FOR FURTHER INFORMATION

Australian Price List Effective May 2013. Note! All prices are exclusive of GST.

POA - Price On Application - denotes non-popular parts. Minimum quantities and order values may apply.

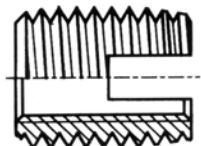

302 Series

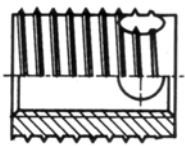

307 Series

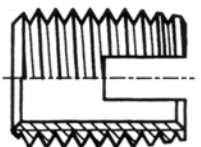

302...40 Series

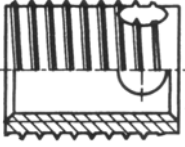

308 Series

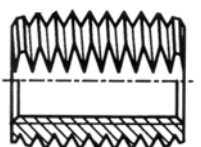

305 Series

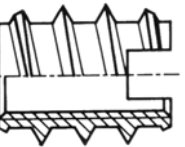

309 Series

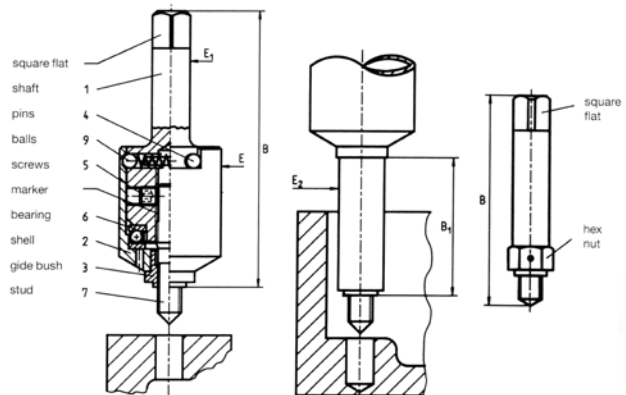

Tapper Installation Tools



Tapper Installation Tools

TAPPER INSTALLATION TOOLS

DRIVER FOR CONTINUOUS INSTALLATION (PRODUCTION)

Part No.	Internal Thread	Price Each	Part No.	Price Each
6200030.00	M3	455.68	6200030.70	38.12
6200040.00	M4	455.68	6200040.70	38.12
6200050.00	M5	583.41	6200050.70	38.12
6200060.00	M6 x 1	583.41	6200060.70	38.12
6200080.00	M8	583.41	6200080.70	38.12
6200100.00	M10	751.86	6200100.70	62.24
6200120.00	M12	751.86	6200120.70	62.24
6200140.00	M14	1342.06	6200140.70	139.02
6200160.00	M16	1342.06	6200160.70	139.02

Part No.	INTERNAL THREAD	Price Each	Part No.	Price Each
6210030.00	M3	702.42	6210030.70	134.34
6210040.00	M4	702.42	6210040.70	134.34
6210050.00	M5	872.57	6210050.70	134.34
6210060.00	M6 x 1	872.57	6210060.70	134.34
6210080.00	M8	872.57	6210080.70	134.34
6210100.00	M10	1203.91	6210100.70	214.99
6210120.00	M12	1203.91	6210120.70	214.99
6210140.00	M14	2007.65	6210140.70	501.33
6210160.00	M16	2007.65	6210160.70	501.33

Australian Price List Effective May 2013. Note! All prices are exclusive of GST.

POA - Price On Application - denotes non-popular parts. Minimum quantities and order values may apply.

Thread Identification and Drill Chart

Metric

DIA IN INCHES	THREAD SIZE MM	ISO COARSE			ISO FINE			BA					
		DRILL SIZE	DRILL SIZE	DIAMETER	OTHER	PITCH	INCH	MM	SIZE	MM	IMCH	PITCH	DRILL
.079	2	.4		2.1					0	6.0	0.236	1	6.2
.087	2.2	.45	No. 42	2.3					2	4.7	0.185	0.8	4.9
.098	2.5	.45	No. 37	2.6					4	3.6	0.142	0.66	3.8
.118	3	.5	1/8	3.2					6	2.8	0.11	0.53	2.9
.138	3.5	0.6	No. 27	3.7					8	2.2	0.86	0.43	2.3
.157	4	.7	11/64	4.2					10	1.7	0.67	0.35	1.7
.197	5	.8	3/64	5.2									
.236	6	1	1/4	6.3									
.276	7	1	9/32	7.3									
.315	8	1.25	21/64	8.3		1	21/64	8.3					
.354	9	1.25		9.4		1		9.3					
.394	10	1.5	13/32	10.4	1*	1.25	13/32	10.25					
.433	11	1.5		11.5	1	1.25		11.25					
.472	12	1.75	31/64	12.5	1.25	1.5	31/64	12.25					
.512	13			13.5		1.5		13.25					
.551	14	2	37/64	14.5	1.25*	1.5	9/16	14.25					
.630	16	2	21/32	16.5		1.5	21/32	16.5					
.709	18	2.5	47/64	18.75	1.5*	2	23/32	18.5					
.787	20	2.5	13/16	20.75	1.5	2	3/16	20.5					
.866	22	2.5		22.75	1.5	2		22.5					
.945	24	3		24.75	1.5	2		24.5					

*M10 X 1, M12 X 1.25, M14 X 1.25, M18 X 1.5 - popular spark plug sizes sizes above M24 available on request.

INCH

DIAMETER INCHES	THREADS PER INCH				DRILL SIZE								
	MM SIZE	THREAD	UNC	BSW (SAE)	UNF	BSF	BSF*	NPT INCH	UNC MM	BSW INCH	UNF, SAE, BSF MM INCH	BSP MM	NPT
.86	2.18	#2	56	40	64				3/32	2.3	No. 37	2.3	
.990	2.51	#3	48		56				No.36	2.7		2.7	
.112	2.84	#4	40		48				No.31	3.0	No.31	3.0	
.125	3.17	#5 (1/8)	40		44		28	27	N0.29	3.4		3.3	3/8 9.9
.138	3.50	#6	32		40				N0.25	3.7	N0.26	3.7	
.164	4.16	#8	32		36				11/64	4.4	11/64	4.4	
.190	4.82	#10 (3/16)		24		32				13/64	5.1	13/64	5.1
.187	4.76	3/16		24	32				13/64	5.0	13/64	5.0	
.216	5.49	#12 (7/32)		24	24					15/64	5.6		
.250	6.35	1/4	20	20	28	26	19	18	17/64	6.7	17/64	6.6	33/64 13.5
.312	7.93	5/16	18	18	24	22			21/64	8.3	21/64	8.2	
.375	9.52	3/8	16	16	24	20	19	18	25/64	9.9	25/64	9.8	21/32 17.0
.437	11.11	7/16	14	14	20	18			29/64	11.5	29/64	11.5	
.500	12.70	1/2	13	12	20	16	14	14	17/32	13.0	33/64	13.0	13/16 21.5
.562	14.28	9/16	12	12	18	16			19/32	14.5	37/64	14.5	
.625	15.87	5/8	11	11	18	14			21/32	16.5	41/64	16.25	
.750	19.05	3/4	10	10	16	12	14	14	25/32	19.75	49/64	19.5	1 1/64 27.0
.875	22.22	7/8	9	9	14	11			29/32	23.0	57/64	22.5	
1.000	25.40	1"	8	8	12 (14)	10	11	11 1/2	1 1/32	26.0	1 1/64	26.0	1 9/32 33.5
1.125	28.57	1 1/8"	7	7	12	9	11		1 5/32	29.5	1 5/32	29.5	
1.250	31.75	1 1/4"	7	7	12	9	11		1 9/32	33.0	1 9/32	32.5	
1.375	34.92	1 3/8"	6	6	12	8	11		1 13/32	36.0	1 13/32	36.0	
1.500	38.10	1 1/2"	6	6	12	8	11		1 17/32	39.0	1 17/32	39.0	

*Nominal diameters for BSP and NPT are not thread diameters but relate to the inside diameter of the pipe.

Terms and Conditions

PAYMENT TERMS:

Net. 30 days. No further credit after 45 days.

PRICES:

Prices are based on purchases of standard package as indicated in the price list and catalogue. Orders received for quantities other than the multiples of our standard packages will be increased to the next highest standard pack multiple. All prices in this list are exclusive of GST.

FREIGHT:

Orders received before 3.00pm will generally be despatched the same day (subject to stock availability). Freight is prepaid on Alcoa Fastening Systems nominated carrier only on invoices over \$150.00 net value.

Freight charges/method as follows:-

Up to 3kg	Air bag or local carrier	\$12.00
3 kg +	Road freight	\$15.00

Where customer nominates a carrier other than Alcoa Fastening Systems carrier, all charges are to their account.

MINIMUM INVOICE:

No order can be processed if under \$50.00 net value. (Excluding freight and GST).

RETURNED GOODS / CREDIT POLICY:

- A. Written authorisation to return material, including an GRN (Goods Return Note) number must be obtained from Alcoa Fastening Systems Sales on 1300 363 049, prior to returning goods for credit. **GOODS THAT DO NOT CARRY OUR AUTHORIZATION NUMBER WILL NOT BE ACCEPTED.**
- B. Accompanying documentation must have the name of the person who authorised the return, the GRN number quoted and a contact name with their phone number from your company.
- C. Handling / Repackaging charge. A 15% handling charge for restocking goods in resaleable condition and a 50% charge for goods that need to be repackaged.

- D. Freight - any freight for returns must be prepaid except where prior written agreement has been obtained from Alcoa Fastening System Sales, in which case Alcoa Fastening Systems nominated carrier **MUST** be used.
- E. Credit for returned goods will be given on the basis of prices paid (as substantiated by accompanying invoice number).
- F. Credit on authorised returns is subject to our inspection and acceptance.

NOTICES AND DISCLAIMERS:

We reserve the right to make changes without notice in our products and in the information published about them. The statements and information in this publication are only for general guidance, and are not warranties or binding descriptions. Requests for more information are welcome. Full AFS terms and conditions are available upon request. The user assumes full responsibility for his or her applications. **THERE IS NO WARRANTY OF FITNESS FOR A PARTICULAR PURPOSE.** No one is authorised by our company to make oral warranties.

All goods remain the property of Alcoa Fastening Systems until payment has been received in full. Prices and terms subject to change within a minimum of 30 days notice. Quality Certificates.

Description

Part No

Certificate of Conformance	D1003-2
Insert Inspection Certificate Stainless Steel	D1003-1
Insert Inspection Certificate Inconel	D1003-5

Note: All charges are per line item, as certificates are issued per line item.

Recoil.® Bringing versatility to a range of applications.

The range of wire thread inserts by Recoil are designed to enable you to produce strong threads in softer materials or more evenly distributed thread loads in harder materials. Thread strengthening needs to be fast, reliable and cost effective - decades of engineering experience means Recoil products carry a global reputation for delivering these OEM essentials.

With a choice of free-running or screw-locking designs, Recoil® offers a broad range of thread insert systems to ensure the best match of product to the application. The standard Recoil free-running insert provides for easy

installation of a female thread, delivering the necessary "holding power" for most applications. For particularly demanding or extreme high-vibration applications, Recoil offers a screw-locking design, which provides a superior locking function in the female thread.

Alcoa Fastening Systems' (AFS) Recoil manufacturing operations are located in Australia, with sales and warehouse facilities strategically placed in North America, Asia and Europe. The European distribution centre is based in Telford, UK.

Contact

Recoil Regional Distribution Centres Australia

Clayton Business Park
1508 Centre Rd Clayton Vic 3168 Australia
PO Box 144 Mount Waverley 3149 Australia
Tel: Sales Australia 1300 363 049
International +613 8545 3333
Fax: Sales Australia 1300 363 154
International +613 8545 3390
Email: afs.sales@alcoa.com.au
Web www.recoil.com.au

Singapore

Block 5, Ang Mo Kio Industrial Park 2A
#04-15 AMK Tech 2
Singapore 567760
Singapore
Telephone (65) 6759 1978
Fax (65) 6759 1582

Shanghai Sales

Area A2, 1st Floor
No. 205 Taigu Road
Waigaocqiao Free Trade Zone
Shanghai, 200131, China
Tel: +86 21 5866 5080
Fax: +86 21 5868 1859

AFS Industrial Distribution Group Headquarters

1925 North MacArthur Drive
Tracy, CA 95376, USA
Tel: 209 839 3000
Fax: 209 839 3022

AFS Industrial Distribution

14300 Clay Terrace Blvd, Suite 250
Carmel, IN 46032, USA
Tel: 800 826 2884
Fax: 800 573 2645

Telford Operations

Unit C, Stafford Park 7
Telford, Shropshire TF3, 3BQ
United Kingdom
Tel: +44 1952 2900 11
Fax: +44 1952 2904 59

China

58 Yinsheng Road, Shengpu
Suzhou industrial Park
Suzhou Jiangsu 215126, China
Tel: 86 010 5921 5077
Fax: 86 010 5921 5100

India Operations

Level 6, Constantia 11
U.N. Brahachari Street
Kolkata 700,017 WB India
Tel: +91 33 4400 0612
Fax: +91 33 4400 0555

Japan/Korea Sales

Alcoa Japan Ltd.
#1013 NBF Hibiya Bldg.
Uchisaiwai-cho, Chiyoda-ku
Tokyo 100-1011
Phone: +81 3 3539 6577
Fax: +81 3 3539 6585

Europe

Alcoa Fastening Systems
St Cosme Operations
9 rue de Cressonnieres
72110 Saint Cosme en Varais, France
Tel: +33 0 2.43.31.41.00
Fax: +33 0 2.43.31.41.41

Alcoa Fastening Systems

Kelkheim Operations
Industriestr. 6
65779 Kelkheim, Germany
Tel: +49 0 6195 8050
Fax: +49 0 6195 2001

Americas

Industrial Fastener Division
8001 Imperial Drive
Waco, TX 76712, USA
P.O. Box 8117
Waco, TX 76714-8117, USA
Tel: 800 388 4825
Fax: 800 798 4825

Installation Tool Division

1 Corporate Drive
Kingston, NY 12401, USA
Tel: 800 278 4825
Fax: 845 334 7333

Latin America Sales

Avenida Parque Lira
79-402 Tacubaya
Mexico C P 11850, USA
Tel: +52 55 5515 1776
Fax: +52 55 5277 7564

Your Authorised Distributor

Disclaimer:
The information contained in this publication is only for general guidance with regard to properties of the products shown and/or the means for selecting such products, and is not intended to create any warranty, express, implied, or statutory; all warranties are contained only in AFS's written quotations, acknowledgments, and/or purchase orders. It is recommended that the user secure specific, up-to-date data and information regarding each application and/or use of such products.

©2012 Alcoa Fastening Systems Ltd. All rights reserved. REV3 - MAY 2103

**Alcoa
Fastening
Systems**

